



FP2

TECHNICAL PROJECT/



FP2
fireplace-2

Spessore/Thickness/
Épaisseur/Stärke **2** cm



technical project	Spessore/ Thickness/ Épaisseur/ Stärke/ 2 cm	HD UGL	R11 outdoor
-------------------	---	---------------	--------------------

Posa sopraelevata/
Raised installation/
Pose surélevée/
Verlegung als Doppelboden/



Posa a secco su erba/
Dry laying on grass/
Pose à sec en appui sur pelouse /
Trockenverlegung auf Gras/



Posa a secco su ghiaia/
Dry laying on gravel/
Pose à sec sur gravier/
Trockenverlegung auf Kies/



Posa su massetto con colla/
Laying on screed with adhesive/
Pose sur chape avec de la colle/
Verlegung auf Estrich mit Kleber/



Posa a secco su sabbia/
Dry laying on sand/
Pose à sec sur sable/
Trockenverlegung auf Sand/



IT - Pregio e sicurezza

Le possibilità applicative del grès porcellanato smaltato per pavimentazioni in spazi interni ed esterni sono vastissime e destinate a superfici alternative, sia di uso pubblico che privato. Materia pregiata e spessorata (**2 cm**) con caratteristiche tecniche e prestazionali impareggiabili. Un progetto esclusivo ed ambizioso, tecnologicamente avanzato. Ideale per applicazioni outdoor. Eccezionale per applicazioni a secco su erba, ghiaia, massetto, sabbia e posa sopraelevata. Pratico e facile da posare. Fruibile in tempo reale.

EN - High quality and safety

Glazed porcelain stoneware offer a huge range of different possibilities for indoor and outdoor finishings intended for both private and public areas. Fine-quality and thickened (**2 cm**) material with unrivalled technical characteristics and performances. An exclusive, ambitious, technologically advanced project. Ideal for outdoor applications. Exceptional for dry applications on grass, gravel, slabs, sand and raised installation. Practical and easy to lay. Ready to use.

FR - Qualité et sécurité

Les possibilités d'application du grès cérame émaillé pour les sols d'intérieur et extérieur sont innombrables et destinées à des surfaces alternatives, aussi bien dans le secteur public que privé. Une matière de grande qualité et l'épaisseur majorée (**2 cm**) possédant des caractéristiques techniques et performancielles sans pareilles. Un projet exclusif et ambitieux, à la pointe de la technologie. Idéal pour des applications à l'extérieur. Exceptionnel pour des applications à sec en appui sur pelouse, gravier, chape, sable et pose surélevée. Pratique et facile à poser. Piétinable immédiatement après la pose.

DE - Prestige und Sicherheit

Es gibt zahlreiche Einsatzmöglichkeiten für Glasiertes Feinsteinzeug als Fußboden in Innen- und Außenbereichen für alternative Anwendungen, in öffentlichen und privaten Oberflächen. Ein kostbares und extra starkes (**2 cm**) Material mit unvergleichbaren technischen Merkmalen und Leistungen. Ein exklusives fortgeschrittenes Projekt. Ideal für Outdoor-Anwendungen. Bestens für die trockene Verlegung auf Gras, Kies, Estrich, Sand und als Doppelboden geeignet. Praktisch und einfach zu verlegen. In Echtzeit nutzbar.



Tipologia di supporti per la posa sopraelevata/
Type of supports for raised floor laying/
Typologie de supports pour la pose surélevée/
Trägerart für die Verlegung als Doppelboden/



Supporto fisso/
Fixed support/
Support fixe/
Fester Träger/ ↓



Supporto regolabile/
Adjustable support/
Support réglable/
Höhenverstellbarer Träger/ ↓



Supporto autolivellante/
Self-levelling support/
Support auto-nivelant/
Selbstnivellierender Träger/ ↓



Esempi di posa / Laying scheme examples / Exemples de pose / Verlegebeispiele

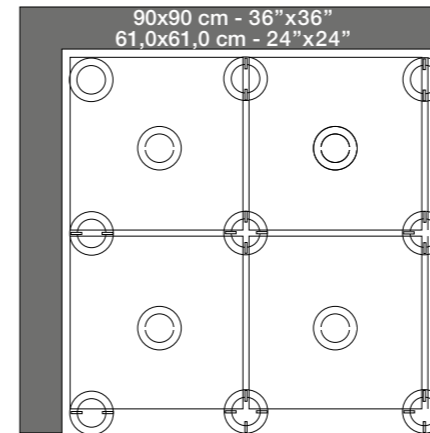

Supporti regolabili e supporti autolivellanti/
Adjustable supports and self-levelling supports/
Supports réglables et supports auto-nivelants/
Höhenverstellbarer Träger und Selbstnivellierender Träger/

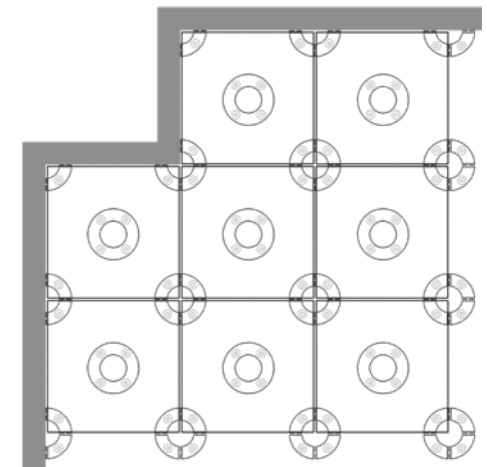
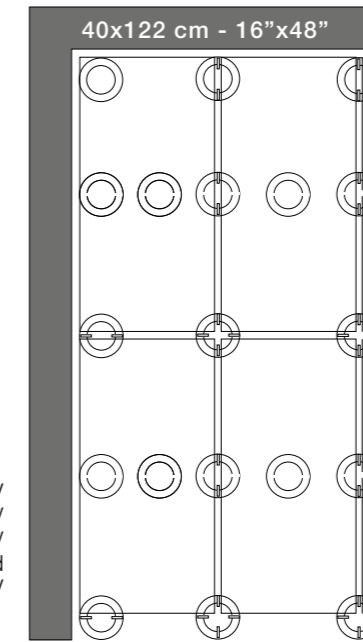

Supporti fissi/
Fixed supports /
Support fixe/
Fester Träger/

SUGGERIMENTI PER LA POSA FLOTTANTE

Raccomandiamo l'uso di un supporto centrale alla lastra al fine di distribuire in modo omogeneo i carichi.

CONSEILS POUR LA POSE FLOTTANTE

Nous recommandons l'utilisation d'un support central sous la dalle afin de répartir uniformément les charges.

TIPS FOR FLOATING INSTALLATION

We recommend the use of a central slab support in order to distribute the loads equally.

EMPFEHLUNGEN FÜR DIE SCHWIMMENDE VERLEGUNG

Wir empfehlen die Verwendung von in der Mitte anzubringenden Stützen, damit die Belastung gleichmäßig verteilt wird.

REFLUSSO DELLE ACQUE SU POSE SOPRAELEVATE:

Si consiglia di dare una pendenza al pavimento con una percentuale non inferiore all'1%.

WATER RUNOFF ON RAISED FLOORS:

We recommend you give the floor a slight slope (at least 1%).

REFLUX DES EAUX SUR POSES SURÉLEVÉES:

On conseille de prévoir une inclinaison minimale du carrelage de 1%.

WASSERRÜCKFLUSS BEI VERLEGUNG AUF HOHLRAUMBÖDEN:

Es wird empfohlen, dem Fußboden ein Gefälle von mindestens 1% zu geben.

SUPPORTI SUPPORTS SUPPORT TRÄGER	ALTEZZA HEIGHT HAUTEUR HÖHE
SUPPORTO FISSO FIXED SUPPORT SUPPORT FIXE FESTER TRÄGER	15 mm
SUPPORTO REGOLABILE ADJUSTABLE SUPPORT SUPPORT RÉGLABLE HÖHENVERSTELLBARER TRÄGER	25 - 40 mm
SUPPORTO AUTOLIVELLANTE SELF-LEVELLING SUPPORT SUPPORT AUTO-NIVELANT SELBSTNIVELLIERENDER TRÄGER	37,5 - 50 mm

Vantaggi/
Advantages/
Avantages/
Vorteile

↑ Removibile, riposizionabile e riutilizzabile/
Can be removed, re-positioned and re-used/
Amovible, repositionnable et réutilisable/
Entfernbar, wiederverlegbar und wiederverwendbar/

↑ Facile, pratico e veloce da installare/
Easy, useful and quick to install/
Facile, pratique et rapide à poser/
Leicht, praktisch und schnell zu installieren/

↑ Tenace e resistente ai carichi di rottura/
Strong and resistant wearing/
Solide et résistant aux charges de rupture/
Widerstandsfähig und bruchfest/

↑ Drenante/
Drainable/
Drainant/
Wasserableitend/

↑ Ingelivo/
Frost resistant/
Ingélif/
Frostbeständig/

↑ Resistente agli agenti atmosferici/
Excellent weather resistance/
Résistant aux agents atmosphériques/
Witterungsbeständig/

↑ Ignifugo/
Fire resistant/
Ignifuge/
Feuerbeständig/

↑ Igienico e facile da pulire/
Hygienic and easy to clean/
Sain et facile à nettoyer/
Hygienisch und einfach zu reinigen/



grès porcellanato smaltato

freeplace-2

IT - Il sistema **FP-2** può essere posato sia con metodi tradizionali su massetto per pavimenti carrabili, che a secco con posa su sabbia, ghiaia o fondi erbosi, in quanto resistente, ingelivo, antiscivolo ed inattaccabile dalle muffe. Negli ultimi tempi, particolare rilevanza e successo sta ottenendo la posa a pavimento sopraelevato con supporti semplici od autolivellanti. La fortuna di questo sistema è sancita oltre che dalla elevata resistenza ai carichi ed ai vari agenti chimici ed atmosferici, dall'estrema facilità e dalla elevata velocità di posa.

EN - The **FP-2** system can be installed using traditional methods on top of slabs for vehicular areas, or dry-laid on sand, gravel or grass, because it is hard-wearing, frost-resistant, slip-resistant and unaffected by mould. Increasingly widespread and successful lately is the installation of the material on raised floors with simple or self-leveling supports. The beauty of this system lies not only in its excellent load resistance and its resistance to the various chemical agents and weather conditions, but also in how quick and easy it is to install.

FR - Le système **FP-2** peut être posé aussi bien suivant des méthodes traditionnelles sur fondation pour les sols carrossables qu'à sec avec une pose sur sable, sur gravier ou sur surfaces en herbe, dans la mesure où il est résistant, ingélif, anti-glisse et inattaquable par les moisissures. Ces derniers temps, la pose surélevée à l'aide de supports simples ou auto-nivelants rencontre un grand intérêt et succès. L'attrait pour ce système s'explique, outre par sa résistance élevée aux charges et aux divers agents chimiques et atmosphériques, par l'extrême facilité et la véritable rapidité de sa pose.

DE - Das **FP-2**-System kann wahlweise mit traditionellen Methoden auf Estrich für befahrbare Böden, als auch für die Verlegung auf Sand-, Kies- oder Gras-Untergründen verwendet werden kann, da es beständig und rutschhemmend ist und nicht von Schimmel angegriffen wird. In letzter Zeit wird den Doppelböden mit einfachen oder selbstnivellierenden Trägern immer mehr Bedeutung beigemessen. Seinen Erfolg hat dieses System außerdem der hohen Belastbarkeit sowie der Chemikalien- und Witterungsbeständigkeit und der extrem leichten und schnellen Verlegung zu verdanken.



Destinazioni d'uso/
Use/
Destinations d'emploi/
Gebrauchsbestimmungen



IT - Il grès porcellanato smaltato spessore **2 cm** ideale per la pavimentazione di aree esterne, sia di uso pubblico che privato.

EN - The **2 cm** thick glazed porcelain stoneware ideal for outdoor flooring in both public and private areas.

FR - Le grès cérame émaillé d'une épaisseur de **2 cm** est idéal pour les sols en extérieurs, aussi bien pour utilisation publique que privée.

DE - Glasiertes Feinsteinzeug **2 cm** Stärke ideal für Fußboden in Außenbereichen, in öffentlichen und privaten Oberflächen.

Per la casa/
For the home/
Pour la maison/
Für die wohnung/

↑ sentieri/
paths/
sentiers/
Pfade/

↑ giardini/
gardens/
jardins/
Gärten/

↑ balconi e terrazze/
balconies and terraces/
balcons et terrasses/
Balkons und Terrassen/

↑ aree cortilive e garage/
courtyards and garages/
cours et garages/
Hofbereiche und garagen/

↑ coordinamento
interno ed esterno/
indoor/outdoor coordination/
coordination entre
intérieur et extérieur/
Abstimmung zwischen
innen- und aussenbereich/

↑ piscine/
swimming pools/
piscines/
Schwimmbäder/

↑ vialetti/
driveways/
allées/
Wege/

↑ verande/
verandas/
vérandas/
veranden/

Per spazi pubblici/
For public spaces/
Pour les espaces publics/
Für öffentlichen bereichen/

↑ camminamenti/
walkways/
passage/
Laufwege/

↑ aree industriali/
industrial areas/
zones industrielles/
Industriegebiete/

↑ piscine/
swimming pools/
piscines/
Schwimmbäder/

↑ stabilimenti balneari/
private beaches/
établissements balnéaires/
Badeeinrichtungen/

↑ ristoranti e bar/
restaurants and bars/
restaurants et bars/
Gaststätten und Bar/

↑ arredo urbano/
urban design/
mobilier urbain/
Stadteinrichtung/

↑ alberghi/
hotels/
hôtels/
Hotels/

↑ piazze e porticati/
squares and arcades/
places et portiques/
Plätze und Atrien/

TECHNICAL PROJECT/



atelier FP2	14
caementum FP2	8
colosseo FP2	28
decapé FP2	44
durango FP2	38
endless FP2	40
etna FP2	34
fjord FP2	46
frühling dekore FP2	24
grey soul FP2	16
limestone FP2	32
meteora FP2	10
my s'tile FP2	12
mon amour FP2	20
north wind FP2	42
pierre bleue FP2	36
slash FP2	30
tecnica FP2	18
Tabella pesi ed imballi / Sizes weight and packaging / Mesures poids et emballages / Tabelle der Gewichte und Verpackungen/	48
Simbologia caratteristica tecnica - grès porcellanato / Symboles technical characteristics - porcelain stoneware / Symboles des caracteristiques techniques - grès cérame / Symbole technischen eigenschaften - feinsteinzeug /	49
Listino Prezzi / Price list / Tarif / Preisliste 2020 €	51

Grès porcellanato/
Porcelain stoneware/
Grès cérame coloré/
Feinsteinzeug/

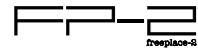

CAEMENTUM

Grès porcellanato impasto colorato
Color body porcelain stoneware / Grès cérame coloré dans la masse / Durchgefärbtes Feinsteinzeug

Colori / Colours / Couleurs / Farben



technical project outdoor	effetto cemento concrete-look effet ciment zementoptik	HD UGL	V2 MODERATE
----------------------------------	---	-------------------------	---------------------------

RS Rettificato/Strutturato
Rectified/Textured

Formati / Sizes / Formats / Formate

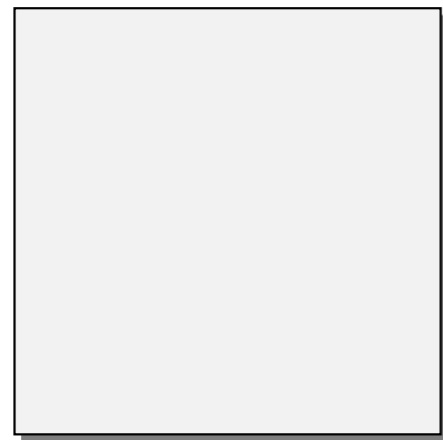

90x90 cm RS . 36"x36" RS



tutti i colori . all colors .
toutes les couleurs . alle Farben

outdoor: CLARUS FP2 | 90x90 cm RS_36"x36" RS
indoor: CLARUS | 90x90 cm R_36"x36" R



Per la disponibilità articolo: www.tuscaniagres.it digitando il codice web segnalato a lato dei formati.
For the item's availability: www.tuscaniagres.it type the web code reported next to the sizes.
Pour vérifier la disponibilité de l'article: www.tuscaniagres.it en saisissant le code web indiqué à coté des formats.
Für die Artikelverfügbarkeit: www.tuscaniagres.it web code eingeben, an der Seite von Formaten angedeutet.



clarus



M9Q0 | 90x90 cm 36"x36" FP2



RS A225

griseo



M8Q9 | 90x90 cm 36"x36" FP2

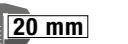

RS A225

FP2 Pezzi Speciali / Special Pieces / Pièces Spéciales / Formteile

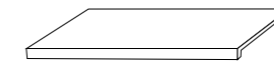

elemento "L"
45x90x5 cm 18"x36" x2" **RS P101**
clarus
griseo

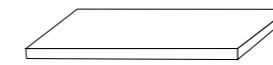

angolare elemento "L"
45x90x5 cm 18"x36" x2" **RS P104**
clarus
griseo

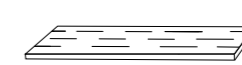

griglia
20x90 cm 8"x36" **RS P118**
clarus
griseo

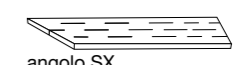

angolo SX
griglia angolo 20x90 cm 8"x36" **RS P108 COPPIA**
clarus
griseo

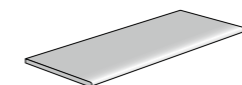
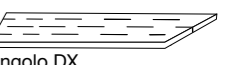

round lineare
45x90 cm 18"x36" **RS P111**
clarus
griseo

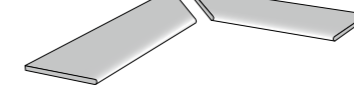

angolo SX
round angolare 45x90 cm 18"x36" **RS P120 COPPIA**
clarus
griseo

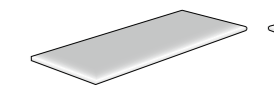

angolo SX
angolo bordo toro 45x90 cm 18"x36" **RS P115**
clarus
griseo

Note - Notes - Notes - Anmerkungen
I pezzi speciali FP2 vengono venduti al pezzo e solo su ordinazione (tempo minimo di consegna 20 gg lavorativi dall'ordine).
The special pieces FP2 are sold by piece and only on request (minimum delivery time 20 working days from date of order).
Les pièces spéciales FP2 sont vendus à la pièce et uniquement sur commande (délai minimum de livraison 20 jours ouvrés à partir de la commande).
Spezial Teile FP2 sind pro Stück verkauft und nur auf Bestellungen produziert. (Lieferzeiten mindesten 20 arbeitstage ab Auftragbestätigung)

Grès porcellanato impasto colorato
Color body porcelain stoneware / Grès cérame coloré dans la masse / Durchgefärbtes Feinsteinzeug

Colori / Colours / Couleurs / Farben



technical project outdoor	effetto cemento concrete-look effet ciment zementoptik	HD UGL	V4 RANDOM
----------------------------------	---	-------------------------	-------------------------

Formati / Sizes / Formats / Formate

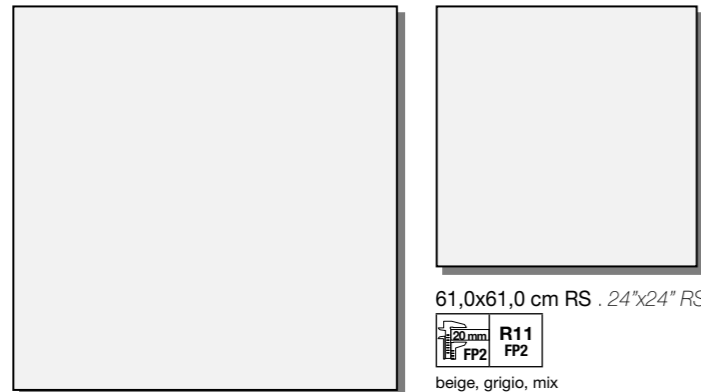

90x90 cm RS . 36"x36" RS



beige, cotto, grigio, mix

90x90 cm RS - decoro.
36"x36" RS - decoro

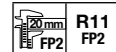

beige, cotto, grigio, mix

61,0x61,0 cm RS . 24"x24" RS



beige, grigio, mix

61,0x61,0 cm RS - decoro .
24"x24" RS - decoro



beige, grigio, mix

GRIGIO FP2 | 90x90 cm RS _36"x36" RS



Per la disponibilità articolo: www.tuscaniagres.it digitando il codice web segnalato a lato dei formati.
For the item's availability: www.tuscaniagres.it type the web code reported next to the sizes.
Pour vérifier la disponibilité de l'article: www.tuscaniagres.it en saisissant le code web indiqué à coté des formats.
Für die Artikelverfügbarkeit: www.tuscaniagres.it web code eingeben, an der Seite von Formaten angedeutet.

beige



L5T4 | 90x90 cm 36"x36" FP2 **RS A225**

L6W9 | 90x90 cm 36"x36" DECORO FP2 **RS A226**

L6T5 | 61,0x61,0 cm 24"x24" FP2 **RS A198**

L7W2 | 61,0x61,0 cm 24"x24" DECORO FP2 **RS A199**

cotto



L5T5 | 90x90 cm 36"x36" FP2 **RS A225**

M5D8 | 90x90 cm 36"x36" DECORO FP2 **RS A226**

grigio



L5T6 | 90x90 cm 36"x36" FP2 **RS A225**

L7W0 | 90x90 cm 36"x36" DECORO FP2 **RS A226**

L0U7 | 61,0x61,0 cm 24"x24" FP2 **RS A198**

L7W3 | 61,0x61,0 cm 24"x24" DECORO FP2 **RS A199**

mix

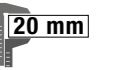

M5D0 | 90x90 cm 36"x36" FP2 **RS A225**

L7W1 | 90x90 cm 36"x36" DECORO FP2 **RS A226**

L6T4 | 61,0x61,0 cm 24"x24" FP2 **RS A198**

L7W4 | 61,0x61,0 cm 24"x24" DECORO FP2 **RS A199**

FP2 Pezzi Speciali / Special Pieces / Pièces Spéciales / Formteile

 elemento "L" *45x90x5 cm 18"x36" x2" RS P101 *30x61,0x5 cm 12"x24" x2" RS P100 /*beige /*cotto /*grigio /*mix	 angolare elemento "L" *45x90x5 cm 18"x36" x2" RS P104 *30x30x5 cm 12"x12" x2" RS P103 /*beige /*cotto /*grigio /*mix	 griglia *20x90 cm 8"x36" RS P118 *20x61,0 cm 8"x24" RS P117 /*beige /*cotto /*grigio /*mix	 angolo SX griglia angolo *20x90 cm 8"x36" RS P108 COPPIA *20x61,0 cm 8"x24" RS P107 COPPIA /*beige /*cotto /*grigio /*mix
 round lineare *45x90 cm 18"x36" RS P111 *30x61,0 cm 12"x24" RS P110 /*beige /*cotto /*grigio /*mix	 angolo SX angolo DX round angolare *45x90 cm 18"x36" RS P120 COPPIA *30x61,0 cm 12"x24" RS P119 COPPIA /*beige /*cotto /*grigio /*mix	 angolo SX angolo DX angolo bordo toro *45x90 cm 18"x36" RS P115 *30x61,0 cm 12"x24" RS P114 /*beige /*cotto /*grigio /*mix	

Note - Notes - Notes - Anmerkungen
I pezzi speciali FP2 vengono venduti al pezzo e solo su ordinazione (tempo minimo di consegna 20 gg lavorativi dall'ordine).
The special pieces FP2 are sold by piece and only on request (minimum delivery time 20 working days from date of order).
Les pièces spéciales FP2 sont vendus à la pièce et uniquement sur commande (délai minimum de livraison 20 jours ouvrés à partir de la commande).
Spezial Teile FP2 sind pro Stück verkauft und nur auf Bestellungen produziert. (Lieferzeiten mindesten 20 arbeitstage ab Auftragbestätigung)

Grès porcellanato impasto colorato
Color body porcelain stoneware / Grès cérame coloré dans la masse / Durchgefärbtes Feinsteinzeug

Colori / Colours / Couleurs / Farben



technical project outdoor	effetto cemento concrete-look effet ciment zementoptik	HD UGL	V3 HIGH
----------------------------------	---	-------------------------	------------------------------

Formati / Sizes / Formats / Formate



122x122 cm RS . 48"x48" RS



my grey

90x90 cm RS . 36"x36" RS

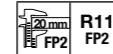

my sand, my camel, my grey

SAND FP2 | 90x90 cm RS_36"x36" RS
elemento a L 45x90x5 cm RS_18"x36"x2" RS



Per la disponibilità articolo: www.tuscaniagres.it digitando il codice web segnalato a lato dei formati.
For the item's availability: www.tuscaniagres.it type the web code reported next to the sizes.
Pour vérifier la disponibilité de l'article: www.tuscaniagres.it en saisissant le code web indiqué à coté des formats.
Für die Artikelverfügbarkeit: www.tuscaniagres.it web code eingeben, an der Seite von Formaten angedeutet.

my grey



M2H3 | 122x122 cm 48"x48" FP2



LOW0 | 90x90 cm 36"x36" FP2



my sand

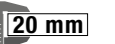

L9V8 | 90x90 cm 36"x36" FP2

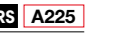

my camel

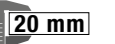

L9V9 | 90x90 cm 36"x36" FP2

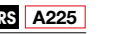

FP2 Pezzi Speciali / Special Pieces / Pièces Spéciales / Formteile

 elemento "L" *45x90x5 cm 18"x36"x2" RS P101 *40x122x5 cm 16"x48"x2" RS P102 •my sand •my camel •/*my grey	 angolare elemento "L" *45x90x5 cm 18"x36"x2" RS P104 *40x122x5 cm 16"x48"x2" RS P105 •my sand •my camel •/*my grey	 griglia *20x90 cm 8"x36" R RS P118 *20x61,0 cm 8"x24" R RS P106 •my sand •my camel •/*my grey	<p>*Griglia e griglia angolo 20x61 cm abbinata al formato 40x122 cm. Grille and corner grille 8"x24" combined with the 16"x48" size.</p> angolo SX griglia angolo *20x90 cm 8"x36" R RS P108 COPPIA *20x61,0 cm 8"x24" R RS P109 COPPIA •my sand •my camel •/*my grey	 angolo DX *20x90 cm 8"x36" R RS P108 COPPIA *20x61,0 cm 8"x24" R RS P109 COPPIA •my sand •my camel •/*my grey
 round lineare *45x90 cm 18"x36" RS P111 *40x122 cm 16"x48" RS P112 •my sand •my camel •/*my grey	 round angolare angolo SX *45x90 cm 18"x36" RS P120 COPPIA *40x122 cm 16"x48" RS P113 COPPIA angolo DX •my sand •my camel •/*my grey	 round bordo toro angolo SX *45x90 cm 18"x36" RS P115 *40x122 cm 16"x48" RS P116 angolo DX •my sand •my camel •/*my grey		

Note - Notes - Notes - Anmerkungen
I pezzi speciali FP2 vengono venduti al pezzo e solo su ordinazione (tempo minimo di consegna 20 gg lavorativi dall'ordine).
The special pieces FP2 are sold by piece and only on request (minimum delivery time 20 working days from date of order).
Les pièces spéciales FP2 sont vendus à la pièce et uniquement sur commande (délai minimum de livraison 20 jours ouvrés à partir de la commande).
Spezial Teile FP2 sind pro Stück verkauft und nur auf Bestellungen produziert. (Lieferzeiten mindesten 20 arbeitstage ab Auftragbestätigung)

Grès porcellanato impasto colorato
Color body porcelain stoneware / Grès cérame coloré dans la masse / Durchgefärbtes Feinsteinzeug

Colori / Colours / Couleurs / Farben



technical project outdoor	effetto cemento concrete-look effet ciment zementoptik	HD UGL	V3 HIGH
----------------------------------	---	-------------------------	------------------------------

RS Rettificato/Strutturato
Rectified/Textured

Formati / Sizes / Formats / Formate

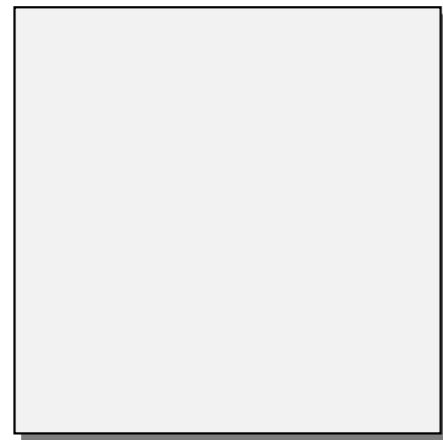

90x90 cm RS . 36"x36" RS



tutti i colori . all colors .
toutes les couleurs . alle Farben

GRIS FP2 | 90x90 cm RS_36"x36" RS



Per la disponibilità articolo: www.tuscaniagres.it digitando il codice web segnalato a lato dei formati.
For the item's availability: www.tuscaniagres.it type the web code reported next to the sizes.
Pour vérifier la disponibilité de l'article: www.tuscaniagres.it en saisissant le code web indiqué à coté des formats.
Für die Artikelverfügbarkeit: www.tuscaniagres.it web code eingeben, an der Seite von Formaten angedeutet.

greige



20 mm

L7V9 | 90x90 cm 36"x36" FP2

RS A225

brun



20 mm

L8V0 | 90x90 cm 36"x36" FP2

RS A225

blanc



20 mm

L7V8 | 90x90 cm 36"x36" FP2

RS A225

gris



20 mm

L8V1 | 90x90 cm 36"x36" FP2

RS A225

FP2 Pezzi Speciali / Special Pieces / Pièces Spéciales / Formteile

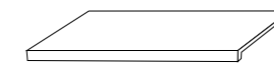

elemento "L"
45x90x5 cm 18"x36" x2" **RS P101**

greige
brun
blanc
gris

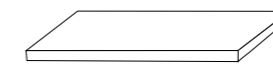

angolare elemento "L"
45x90x5 cm 18"x36" x2" **RS P104**

greige
brun
blanc
gris

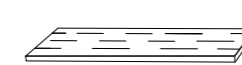

griglia
20x90 cm 8"x36" **RS P118**

greige
brun
blanc
gris

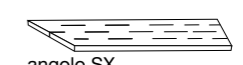

angolo SX
griglia angolo 20x90 cm 8"x36" **RS P108 COPPIA**

greige
brun
blanc
gris

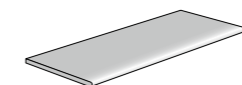
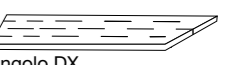

round lineare
45x90 cm 18"x36" **RS P111**

greige
brun
blanc
gris



angolo SX
round angolare 45x90 cm 18"x36" **RS P120 COPPIA**

greige
brun
blanc
gris

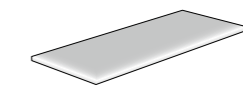

angolo SX
angolo bordo toro 45x90 cm 18"x36" **RS P115**

greige
brun
blanc
gris

Note - Notes - Notes - Anmerkungen
I pezzi speciali FP2 vengono venduti al pezzo e solo su ordinazione (tempo minimo di consegna 20 gg lavorativi dall'ordine).
The special pieces FP2 are sold by piece and only on request (minimum delivery time 20 working days from date of order).
Les pièces spéciales FP2 sont vendus à la pièce et uniquement sur commande (délai minimum de livraison 20 jours ouvrés à partir de la commande).
Spezial Teile FP2 sind pro Stück verkauft und nur auf Bestellungen produziert. (Lieferzeiten mindesten 20 arbeitstage ab Auftragbestätigung)

Grès porcellanato impasto colorato
Color body porcelain stoneware / Grès cérame coloré dans la masse / Durchgefärbtes Feinsteinzeug

Colori / Colours / Couleurs / Farben



RS Rettificato/Strutturato
Rectified/Textured

technical project outdoor	effetto cemento concrete-look effet ciment zementoptik	HD UGL	V3 HIGH
----------------------------------	---	-------------------------	-----------------------

Formati / Sizes / Formats / Formate



122x122 cm RS . 48"x48" RS

R11
FP2

mid, dark



90x90 cm RS . 36"x36" RS

R11
FP2

sand, light, mid, dark

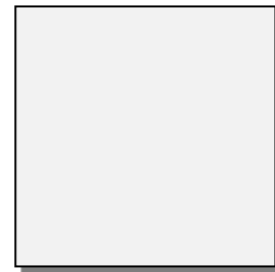

61,0x61,0 cm RS .
24"x24" RS

R11
FP2

sand, light, mid, dark



40x122 cm RS . 16"x48" RS

R11
FP2

light, mid, dark



45x90 cm RS . 18"x36" RS

R11
FP2

sand, light, mid, dark



MID FP2 | 45x90 cm RS_18"x36" RS

Per la disponibilità articolo: www.tuscaniagres.it digitando il codice web segnalato a lato dei formati.
For the item's availability: www.tuscaniagres.it type the web code reported next to the sizes.
Pour vérifier la disponibilité de l'article: www.tuscaniagres.it en saisissant le code web indiqué à coté des formats.
Für die Artikelverfügbarkeit: www.tuscaniagres.it web code eingeben, an der Seite von Formaten angedeutet.

sand



20 mm

L5T2 90x90 cm 36"x36" FP2

RS A225

I7H0 61,0x61,0 cm 24"x24" FP2

RS A198

M4L0 45x90 cm 18"x36" FP2

RS A171

light



20 mm

M4D8 90x90 cm 36"x36" FP2

RS A225

H3U7 61,0x61,0 cm 24"x24" FP2

RS A198

H6Z6 45x90 cm 18"x36" FP2

RS A171

L8T8 40x122 cm 16"x48" FP2

RS A150

mid



20 mm

M2E6 122x122 cm 48"x48" FP2

RS A232

L5T1 90x90 cm 36"x36" FP2

RS A225

H3U9 61,0x61,0 cm 24"x24" FP2

RS A198

H6Z7 45x90 cm 18"x36" FP2

RS A171

L8T7 40x122 cm 16"x48" FP2

RS A150

dark



20 mm

L9S9 122x122 cm 48"x48" FP2

RS A232

L5T0 90x90 cm 36"x36" FP2

RS A225

H4U1 61,0x61,0 cm 24"x24" FP2

RS A198

H6Z8 45x90 cm 18"x36" FP2

RS A171

L8T9 40x122 cm 16"x48" FP2

RS A150

FP2 Pezzi Speciali / Special Pieces / Pièces Spéciales / Formteile

▲ Griglia e griglia angolo 20x61 cm abbinata ai formati 122x122 cm e 40x122 cm.
Grille and corner grille 8"x24" combined with the 48"x48" and 16"x48" size.

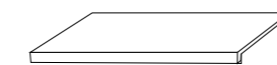

elemento "L"

*45x90x5 cm 18"x36"x2" **RS P101**
*30x61,0x5 cm 12"x24"x2" **RS P100**
*40x122x5 cm 16"x48"x2" **RS P102**

*/• sand
*/•▲ light
*/•▲ mid
*/•▲ dark



angolare elemento "L"

*45x90x5 cm 18"x36"x2" **RS P104**
*30x30x5 cm 12"x12"x2" **RS P103**
*40x122x5 cm 16"x48"x2" **RS P105**

*/• sand
*/•▲ light
*/•▲ mid
*/•▲ dark



griglia

*20x90 cm 8"x36" **RS P118**
*20x61,0 cm 8"x24" **RS P117**
*20x61,0 cm 8"x24" **RS P106**

*/• sand
*/•▲ light
*/•▲ mid
*/•▲ dark

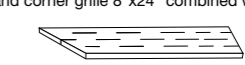

angolo SX

griglia angolo *20x90 cm 8"x36" **RS P108 COPPIA**
*20x61,0 cm 8"x24" **RS P107 COPPIA**
*20x61,0 cm 8"x24" **RS P109 COPPIA**

*/• sand
*/•▲ light
*/•▲ mid
*/•▲ dark

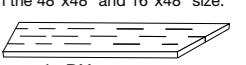

angolo DX

griglia angolo *20x90 cm 8"x36" **RS P108 COPPIA**
*20x61,0 cm 8"x24" **RS P107 COPPIA**
*20x61,0 cm 8"x24" **RS P109 COPPIA**

*/• sand
*/•▲ light
*/•▲ mid
*/•▲ dark



round lineare

*45x90 cm 18"x36" **RS P111**
*30x61,0 cm 12"x24" **RS P110**
*40x122 cm 16"x48" **RS P112**

*/• sand
*/•▲ light
*/•▲ mid
*/•▲ dark



angolo SX

round angolare *45x90 cm 18"x36" **RS P120 COPPIA**
*30x61,0 cm 12"x24" **RS P119 COPPIA**
*40x122 cm 16"x48" **RS P113 COPPIA**

*/• sand
*/•▲ light
*/•▲ mid
*/•▲ dark

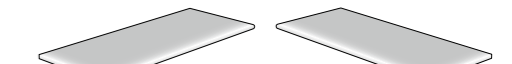

angolo SX

angolo bordo toro *45x90 cm 18"x36" **RS P115**
*30x61,0 cm 12"x24" **RS P114**
*40x122 cm 16"x48" **RS P116**

*/• sand
*/•▲ light
*/•▲ mid
*/•▲ dark

Note - Notes - Notes - Anmerkungen

I pezzi speciali FP2 vengono venduti al pezzo e solo su ordinazione (tempo minimo di consegna 20 gg lavorativi dall'ordine).
The special pieces FP2 are sold by piece and only on request (minimum delivery time 20 working days from date of order).
Les pièces spéciales FP2 sont vendus à la pièce et uniquement sur commande (délai minimum de livraison 20 jours ouvrés à partir de la commande).
Spezial Teile FP2 sind pro Stück verkauft und nur auf Bestellungen produziert. (Lieferzeiten mindesten 20 arbeitstage ab Auftragbestätigung)

Grès porcellanato impasto colorato
Color body porcelain stoneware / Grès cérame coloré dans la masse / Durchgefärbtes Feinsteinzeug

Colori / Colours / Couleurs / Farben

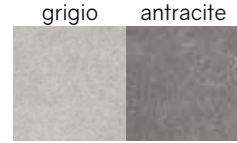

technical project outdoor	effetto cemento concrete-look effet ciment zementoptik	HD UGL	V2 MODERATE
----------------------------------	---	-------------------------	---------------------------

RS Rettificato/Strutturato
Rectified/Textured

Formati / Sizes / Formats / Formate

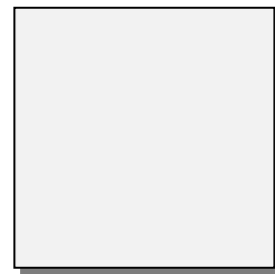

61,0x61,0 cm RS .
24"x24" RS

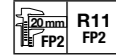

tutti i colori . all colors .
toutes les couleurs . alle Farben

ANTRACITE FP2 | 61,0x61,0 cm RS_24"x24" RS



Per la disponibilità articolo: www.tuscaniagres.it digitando il codice web segnalato a lato dei formati.
For the item's availability: www.tuscaniagres.it type the web code reported next to the sizes.
Pour vérifier la disponibilité de l'article: www.tuscaniagres.it en saisissant le code web indiqué à coté des formats.
Für die Artikelverfügbarkeit: www.tuscaniagres.it web code eingeben, an der Seite von Formaten angedeutet.

grigio



I502 | 61,0x61,0 cm 24"x24" FP2



RS **A198**

antracite



I8N3 | 61,0x61,0 cm 24"x24" FP2

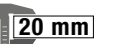

RS **A198**

FP2 Pezzi Speciali / Special Pieces / Pièces Spéciales / Formteile

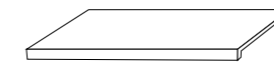

elemento "L"
30x61,0x5 cm 12"x24"x2" **RS** **P100**
grigio
antracite

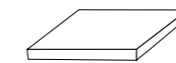

angolare elemento "L"
30x30x5 cm 12"x12"x2" **RS** **P103**
grigio
antracite

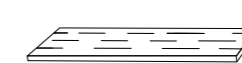

griglia
20x61,0 cm 8"x24" **RS** **P117**
grigio
antracite

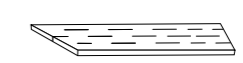

angolo SX
griglia angolo 20x61,0 cm 8"x24" **RS** **P107 COPPIA**
grigio
antracite

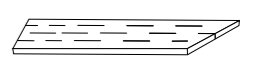

round lineare
30x61,0 cm 12"x24" **RS** **P110**
grigio
antracite

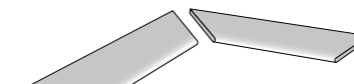

angolo SX
round angolare 30x61,0 cm 12"x24" **RS** **P119 COPPIA**
grigio
antracite

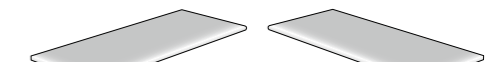

angolo SX
angolo bordo toro 30x61,0 cm 12"x24" **RS** **P114**
grigio
antracite

Note - Notes - Notes - Anmerkungen
I pezzi speciali FP2 vengono venduti al pezzo e solo su ordinazione (tempo minimo di consegna 20 gg lavorativi dall'ordine).
The special pieces FP2 are sold by piece and only on request (minimum delivery time 20 working days from date of order).
Les pièces spéciales FP2 sont vendus à la pièce et uniquement sur commande (délai minimum de livraison 20 jours ouvrés à partir de la commande).
Spezial Teile FP2 sind pro Stück verkauft und nur auf Bestellungen produziert. (Lieferzeiten mindesten 20 arbeitstage ab Auftragbestätigung)

Grès porcellanato
Porcelain stoneware / Grès cérame / Feinsteinzeug

Colori / Colours / Couleurs / Farben



technical project outdoor	effetto cemento concrete-look effet ciment zementoptik	HD UGL	V4 RANDOM
----------------------------------	---	---------------	-------------------------

Formati / Sizes / Formats / Formate



122x122 cm RS . 48"x48" RS



blanc, gris, crème

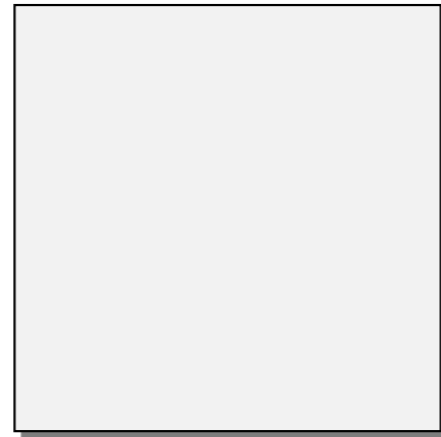

90x90 cm RS . 36"x36" RS

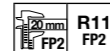

tutti i colori . all colors .
toutes les couleurs . alle Farben

90x90 cm RS - DECORO .
36"x36" RS - DECORO

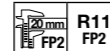

tutti i colori . all colors .
toutes les couleurs . alle Farben

TERRE e TERRE decoro FP2 | 90x90 cm RS_36"x36" RS

RS Rettificato/Strutturato
Rectified/Textured



Per la disponibilità articolo: www.tuscaniagres.it digitando il codice web segnalato a lato dei formati.
For the item's availability: www.tuscaniagres.it type the web code reported next to the sizes.
Pour vérifier la disponibilité de l'article: www.tuscaniagres.it en saisissant le code web indiqué à coté des formats.
Für die Artikelverfügbarkeit: www.tuscaniagres.it web code eingeben, an der Seite von Formaten angeudetet.

crème



20 mm

M9E9 | 122x122 cm 48"x48" FP2

RS A232

M3E1 | 90x90 cm 36"x36" FP2

RS A225

M3E6 | 90x90 cm 36"x36" DECORO FP2

RS B226

blanc



20 mm

M9E4 | 122x122 cm 48"x48" FP2

RS A232

M3E0 | 90x90 cm 36"x36" FP2

RS A225

M3E5 | 90x90 cm 36"x36" DECORO FP2

RS B226

terre



20 mm

M2E9 | 90x90 cm 36"x36" FP2

RS A225

M3E4 | 90x90 cm 36"x36" DECORO FP2

RS B226

gris



20 mm

M0F2 | 122x122 cm 48"x48" FP2

RS A232

M3E2 | 90x90 cm 36"x36" FP2

RS A225

M3E7 | 90x90 cm 36"x36" DECORO FP2

RS B226

noir

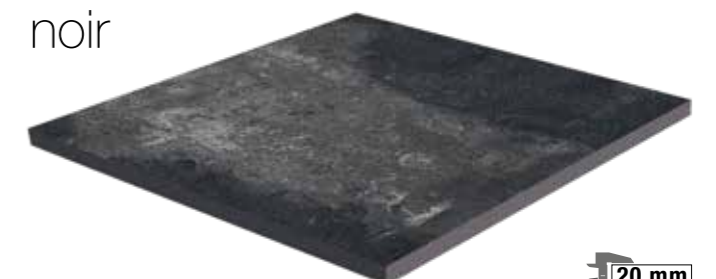

20 mm

M3E3 | 90x90 cm 36"x36" FP2

RS A225

M3E8 | 90x90 cm 36"x36" DECORO FP2

RS B226

Grès porcellanato
Porcelain stoneware / Grès cérame / Feinsteinzeug

Decori / Decors / Décors / Dekors

decoro FP2 90x90 cm 36"x36" FP2 **RS**

12 soggetti diversi, miscelazione casuale. Disponibile in tutti i colori. / 12 assorted motifs, random mix. Available in all colours. / 12 sujets différents, mélange aléatoire. Disponible dans toutes les gammes de couleur. / 12 verschiedene Motive, Zufallsmischung. In allen Farben verfügbar.

blanc decoro



M3E5 | 90x90 cm 36"x36" DECORO FP2 **RS B226**

gris decoro

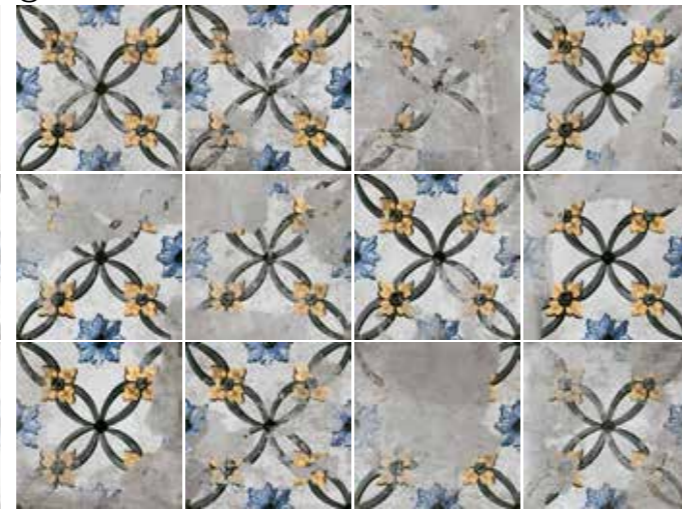

M3E7 | 90x90 cm 36"x36" DECORO FP2 **RS B226**

noir decoro

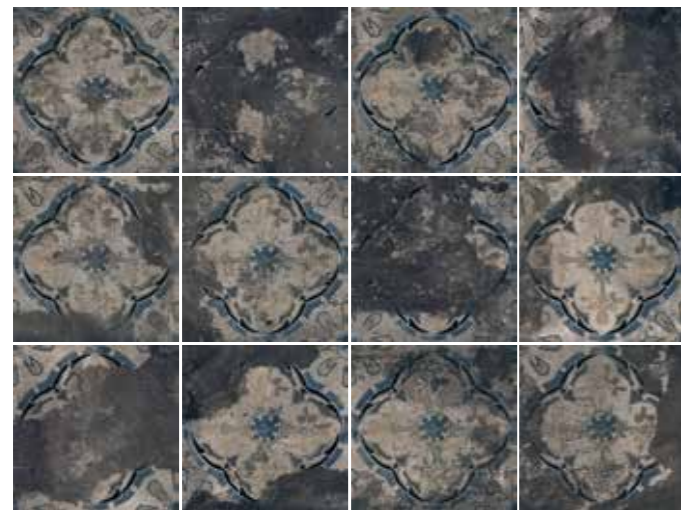

M3E8 | 90x90 cm 36"x36" DECORO FP2 **RS B226**

Decori / Decors / Décors / Dekors

decoro FP2 90x90 cm 36"x36" FP2 **RS**

12 soggetti diversi, miscelazione casuale. Disponibile in tutti i colori. / 12 assorted motifs, random mix. Available in all colours. / 12 sujets différents, mélange aléatoire. Disponible dans toutes les gammes de couleur. / 12 verschiedene Motive, Zufallsmischung. In allen Farben verfügbar.

crème decoro

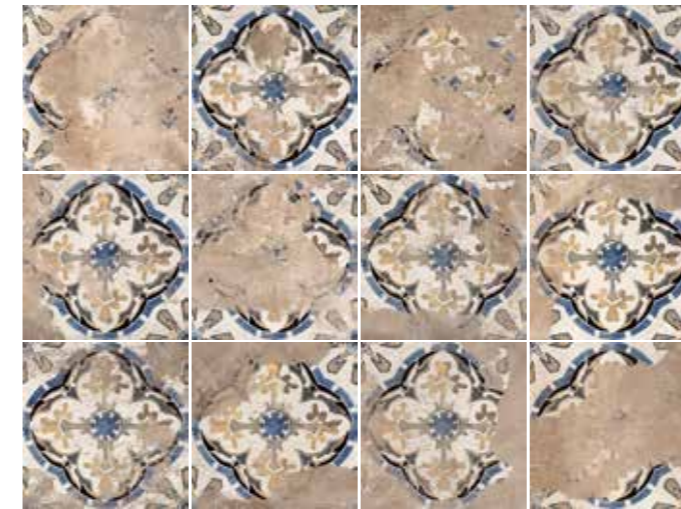

M3E6 | 90x90 cm 36"x36" DECORO FP2 **RS B226**

terre decoro

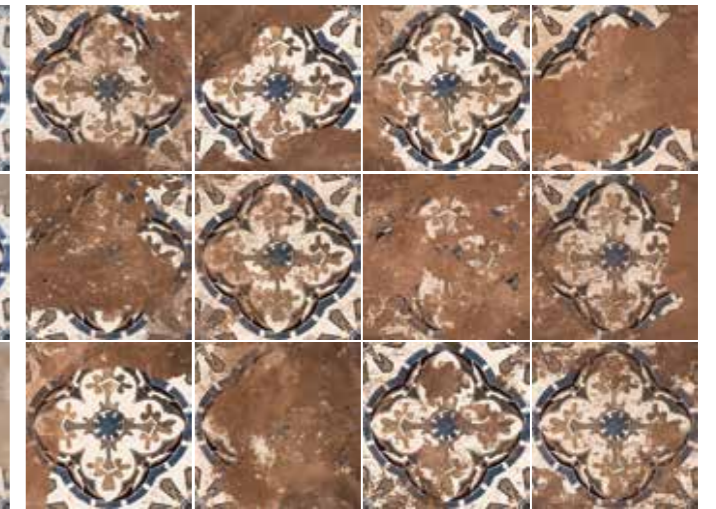

M3E4 | 90x90 cm 36"x36" DECORO FP2 **RS B226**

FP2 Pezzi Speciali / Special Pieces / Pièces Spéciales / Formteile

*Griglia e griglia angolo 20x61 cm abbinato al formato 122x122 cm.
Grille and corner grille 8"x24" combined with the 48"x48" size.

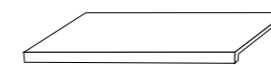

elemento "L"
•45x90x5 cm 18"x36" x2" **RS P101**
•40x122x5 cm 16"x48" x2" **RS P102**

•/*blanc
•/*gris
•noir
•/*crème
•terre

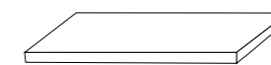

angolare elemento "L"
•45x90x5 cm 18"x36" x2" **RS P104**
•40x122x5 cm 16"x48" x2" **RS P105**

•/*blanc
•/*gris
•noir
•/*crème
•terre

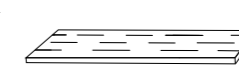

griglia
•20x90 cm 8"x36" R **RS P118**
•20x61,0 cm 8"x24" R **RS P106**

•/*blanc
•/*gris
•noir
•/*crème
•terre

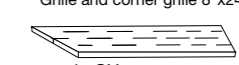

angolo SX
griglia angolo
•20x90 cm 8"x36" R **RS P108 COPPIA**
•20x61,0 cm 8"x24" R **RS P109 COPPIA**

•/*blanc
•/*gris
•noir
•/*crème
•terre

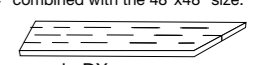

angolo DX

•/*blanc
•/*gris
•noir
•/*crème
•terre

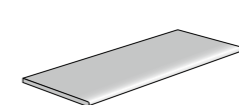

round lineare
•45x90 cm 18"x36" **RS P111**
•40x122 cm 16"x48" **RS P112**

•/*blanc
•/*gris
•noir
•/*crème
•terre

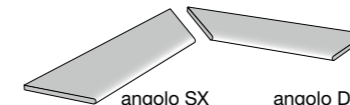

angolo SX
round angolare
•45x90 cm 18"x36" **RS P120 COPPIA**
•40x122 cm 16"x48" **RS P113 COPPIA**

•/*blanc
•/*gris
•noir
•/*crème
•terre

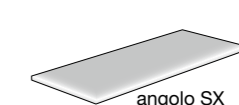

angolo SX
angolo bordo toro
•45x90 cm 18"x36" **RS P115**
•40x122 cm 16"x48" **RS P116**

•/*blanc
•/*gris
•noir
•/*crème
•terre

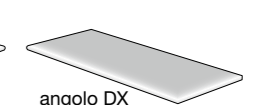

angolo DX

•/*blanc
•/*gris
•noir
•/*crème
•terre

Note - Notes - Notes - Anmerkungen
I pezzi speciali FP2 vengono venduti al pezzo e solo su ordinazione (tempo minimo di consegna 20 gg lavorativi dall'ordine).
The special pieces FP2 are sold by piece and only on request (minimum delivery time 20 working days from date of order).
Les pièces spéciales FP2 sont vendus à la pièce et uniquement sur commande (délai minimum de livraison 20 jours ouvrés à partir de la commande).
Spezial Teile FP2 sind pro Stück verkauft und nur auf Bestellungen produziert. (Lieferzeiten mindesten 20 arbeitstage ab Auftragbestätigung)

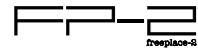

FRÜHLING DEKORE

Grès porcellanato
Porcelain stoneware / Grès cérame / Feinsteinzeug

Colori / Colours / Couleurs / Farben



technical project FP2 outdoor	effetto cemento concrete-look effet ciment zementoptik	HD UGL	V2 MODERATE
--	---	-------------------------	-----------------------

RS Rettificato/Strutturato
Rectified/Textured

Formati / Sizes / Formats / Formate **FP2**

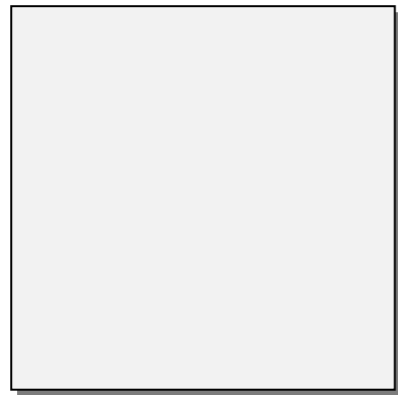

90x90 cm RS . 36"x36" RS



tutti i colori . all colors .
toutes les couleurs . alle Farben

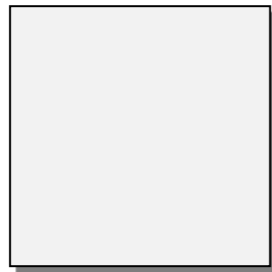

61,0x61,0 cm RS . 24"x24" RS



tutti i colori . all colors .
toutes les couleurs . alle Farben

floor: FRÜHLING DEKORE BLUMEN FP2 | 61,0x61,0 cm RS_24"x24" RS
wall: DECAPÉ MIELE | 26,0x160,0 cm R_10"x62" R



Per la disponibilità articolo: www.tuscaniagres.it digitando il codice web segnalato a lato dei formati.

For the item's availability: www.tuscaniagres.it type the web code reported next to the sizes.

Pour vérifier la disponibilité de l'article: www.tuscaniagres.it en saisissant le code web indiqué à coté des formats.

Für die Artikelverfügbarkeit: www.tuscaniagres.it web code eingeben, an der Seite von Formaten angedeutet.

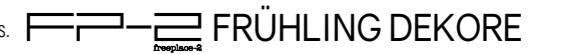

monofaccia arabisch



M5W4 | 90x90 cm 36"x36" FP2



M5W3 | 61,0x61,0 cm 24"x24" FP2



monofaccia geometrica

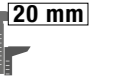

M3W6 | 90x90 cm 36"x36" FP2

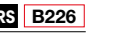

M3W9 | 61,0x61,0 cm 24"x24" FP2

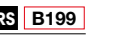

monofaccia lillie



M3W4 | 90x90 cm 36"x36" FP2



M3W7 | 61,0x61,0 cm 24"x24" FP2



monofaccia blumen

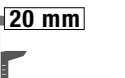
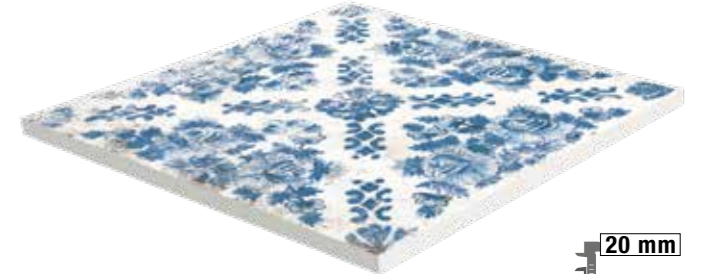

M3W5 | 90x90 cm 36"x36" FP2



M3W8 | 61,0x61,0 cm 24"x24" FP2



Grès porcellanato
Porcelain stoneware / Grès cérame / Feinsteinzeug

8 soggetti diversi, miscelazione casuale. Disponibile in tutti i colori. / 8 assorted motifs, random mix. Available in all colours.
8 sujets différents, mélange aléatoire. Disponible dans toutes les gammes de couleur. / 8 verschiedene Motive, Zufallsmischung. In allen Farben verfügbar.

monofaccia arabisch



M5W4 | 90x90 cm 36"x36" FP2

RS B226

M5W3 | 61,0x61,0 cm 24"x24" FP2

RS B199

monofaccia lillie



M3W4 | 90x90 cm 36"x36" FP2

RS B226

M3W7 | 61,0x61,0 cm 24"x24" FP2

RS B199

Per la disponibilità articolo: www.tuscaniagres.it digitando il codice web segnalato a lato dei formati.

For the item's availability: www.tuscaniagres.it type the web code reported next to the sizes.

Pour vérifier la disponibilité de l'article: www.tuscaniagres.it en saisissant le code web indiqué à coté des formats.

Für die Artikelverfügbarkeit: www.tuscaniagres.it web code eingeben, an der Seite von Formaten angedeutet.

8 soggetti diversi, miscelazione casuale. Disponibile in tutti i colori. / 8 assorted motifs, random mix. Available in all colours.
8 sujets différents, mélange aléatoire. Disponible dans toutes les gammes de couleur. / 8 verschiedene Motive, Zufallsmischung. In allen Farben verfügbar.

monofaccia geometrica



M3W6 | 90x90 cm 36"x36" FP2

RS B226

M3W9 | 61,0x61,0 cm 24"x24" FP2

RS B199

monofaccia blumen



M3W5 | 90x90 cm 36"x36" FP2

RS B226

M3W8 | 61,0x61,0 cm 24"x24" FP2

RS B199

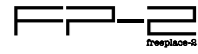

COLOSSEO

Grès porcellanato
Porcelain stoneware / Grès cérame / Feinsteinzeug

Colori / Colours / Couleurs / Farben



technical project outdoor	effetto pietra stone-look effet pierre steinoptik	HD UGL	V3 HIGH
----------------------------------	--	---------------	-----------------------

RS Rettificato/Strutturato
Rectified/Textured

Formati / Sizes / Formats / Formate

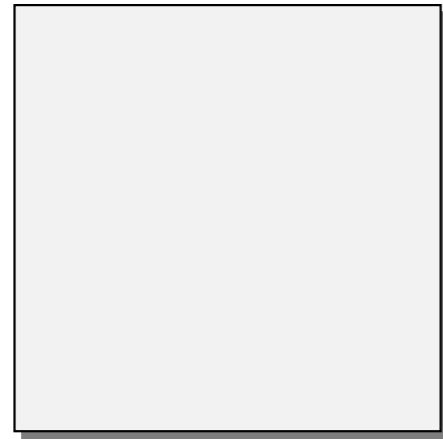

90x90 cm RS . 36"x36" RS



tutti i colori . all colors .
toutes les couleurs . alle Farben

floor: BEIGE FP2 | 90x90 cm RS_36"x36" RS
wall: BEIGE | 90x90 cm RS_36"x36" RS

BEIGE FP2 | 90x90 cm RS_36"x36" RS
elemento a L 45x90x5 cm RS_18"x36"x2" RS



Per la disponibilità articolo: www.tuscaniagres.it digitando il codice web segnalato a lato dei formati.
For the item's availability: www.tuscaniagres.it type the web code reported next to the sizes.
Pour vérifier la disponibilité de l'article: www.tuscaniagres.it en saisissant le code web indiqué à coté des formats.
Für die Artikelverfügbarkeit: www.tuscaniagres.it web code eingeben, an der Seite von Formaten angedeutet.



beige



M4U8 | 90x90 cm 36"x36" FP2



RS A225

grigio



M4U9 | 90x90 cm 36"x36" FP2

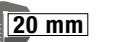

RS A225

FP2 Pezzi Speciali / Special Pieces / Pièces Spéciales / Formteile

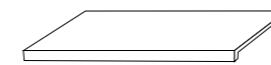

elemento "L"
45x90x5 cm 18"x36" x2" **RS P101**
beige
grigio

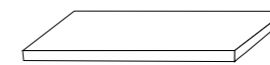

angolare elemento "L"
45x90x5 cm 18"x36" x2" **RS P104**
beige
grigio

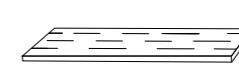

griglia
20x90 cm 8"x36" **RS P118**
beige
grigio



angolo SX
griglia angolo 20x90 cm 8"x36" **RS P108 COPPIA**
beige
grigio

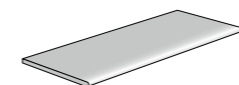
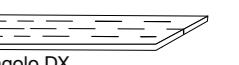

round lineare
45x90 cm 18"x36" **RS P111**
beige
grigio

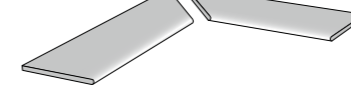

angolo SX
round angolare 45x90 cm 18"x36" **RS P120 COPPIA**
beige
grigio

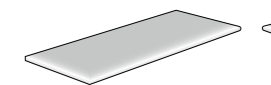

angolo SX
angolo bordo toro 45x90 cm 18"x36" **RS P115**
beige
grigio

Note - Notes - Notes - Anmerkungen
I pezzi speciali FP2 vengono venduti al pezzo e solo su ordinazione (tempo minimo di consegna 20 gg lavorativi dall'ordine).
The special pieces FP2 are sold by piece and only on request (minimum delivery time 20 working days from date of order).
Les pièces spéciales FP2 sont vendus à la pièce et uniquement sur commande (délai minimum de livraison 20 jours ouvrés à partir de la commande).
Spezial Teile FP2 sind pro Stück verkauft und nur auf Bestellungen produziert. (Lieferzeiten mindesten 20 arbeitstage ab Auftragbestätigung)

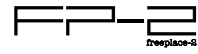

SLASH

Grès porcellanato
Porcelain stoneware / Grès cérame / Feinsteinzeug

Colori / Colours / Couleurs / Farben

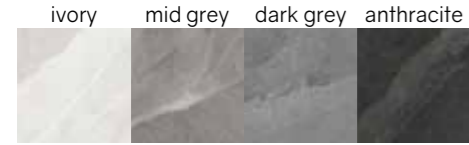

technical project outdoor	effetto pietra stone-look effet pierre steinoptik	HD UGL	V4 RANDOM
----------------------------------	--	-------------------	-------------------------

RS Rettificato/Strutturato
Rectified/Textured

Formati / Sizes / Formats / Formate



61,0x122 cm RS .
24"x48" RS



tutti i colori . all colors .
toutes les couleurs . alle Farben

Per la disponibilità articolo: www.tuscaniagres.it digitando il codice web segnalato a lato dei formati.
For the item's availability: www.tuscaniagres.it type the web code reported next to the sizes.
Pour vérifier la disponibilité de l'article: www.tuscaniagres.it en saisissant le code web indiqué à coté des formats.
Für die Artikelverfügbarkeit: www.tuscaniagres.it web code eingeben, an der Seite von Formaten angedeutet.



ivory



20 mm

M7W0 | 61,0x122 cm 24"x48" FP2

RS A184

mid grey



20 mm

M7W1 | 61,0x122 cm 24"x48" FP2

RS A184

dark grey



20 mm

M7W2 | 61,0x122 cm 24"x48" FP2

RS A184

anthracite



20 mm

M7W4 | 61,0x122 cm 24"x48" FP2

RS A184

IVORY, MID GREY FP2 | 61,0x122 cm RS_24"x48" RS
elemento a L 61,0x122x5 cm RS_24"x48"x2" RS - griglia, griglia angolo 20x122 cm RS_8"x48" RS



FP2 Pezzi Speciali / Special Pieces / Pièces Spéciales / Formteile

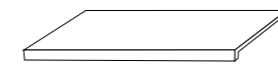

elemento "L"
61,0x122x5 cm 24"x48" x2" **RS P121**

ivory
mid grey
dark grey
anthracite

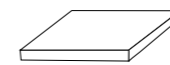

angolare elemento "L"
61,0x61,0x5 cm 24"x24"x2" **RS P122**

ivory
mid grey
dark grey
anthracite

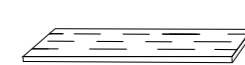

griglia
20x122 cm 8"x48" **RS P123**

ivory
mid grey
dark grey
anthracite

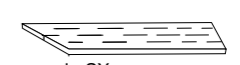

angolo SX
griglia angolo
20x122 cm 8"x48" **RS P124 COPPIA**

ivory
mid grey
dark grey
anthracite

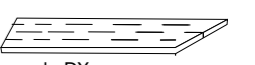

angolo DX

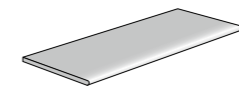

round lineare
30x122 cm 12"x48" **RS P125**

ivory
mid grey
dark grey
anthracite

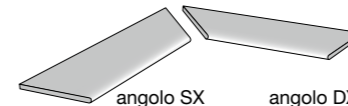

round angolare
30x122 cm 12"x48" **RS P126 COPPIA**

ivory
mid grey
dark grey
anthracite

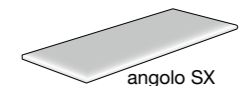

angolo bordo toro
30x122 cm 12"x48" **RS P127**

ivory
mid grey
dark grey
anthracite

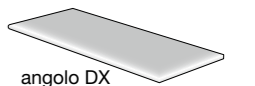

angolo DX

Note - Notes - Notes - Anmerkungen
I pezzi speciali FP2 vengono venduti al pezzo e solo su ordinazione (tempo minimo di consegna 20 gg lavorativi dall'ordine).
The special pieces FP2 are sold by piece and only on request (minimum delivery time 20 working days from date of order).
Les pièces spéciales FP2 sont vendus à la pièce et uniquement sur commande (délai minimum de livraison 20 jours ouvrés à partir de la commande).
Spezial Teile FP2 sind pro Stück verkauft und nur auf Bestellungen produziert. (Lieferzeiten mindesten 20 arbeitstage ab Auftragbestätigung)

Grès porcellanato impasto colorato
Color body porcelain stoneware / Grès cérame coloré dans la masse / Durchgefärbtes Feinsteinzeug

Colori / Colours / Couleurs / Farben



technical project outdoor	effetto pietra stone-look effet pierre steinoptik	HD UGL	V3 HIGH
----------------------------------	--	---------------	-----------------------

Formati / Sizes / Formats / Formate

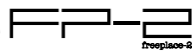

COAL FP2 | 61,0x61,0 cm RS_24"x24" RS - griglia 20x61,0 cm RS_8"x24" RS - griglia angolo SX e griglia angolo DX 20x61,0 cm RS_8"x24" RS

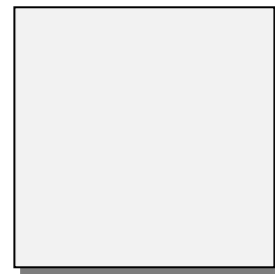

61,0x61,0 cm RS .
24"x24" RS



tutti i colori . all colors .
toutes les couleurs . alle Farben



RS Rettificato/Strutturato
Rectified/Textured

FP2 Pezzi Speciali / Special Pieces / Pièces Spéciales / Formteile



elemento "L"
30x61,0x5 cm 12"x24"x2" **RS P100**

ice
gun metal
coal
beige
ash



angolare elemento "L"
30x30x5 cm 12"x12"x2" **RS P103**

ice
gun metal
coal
beige
ash

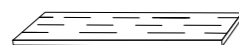

griglia
20x61,0 cm 8"x24" **RS P117**

ice
gun metal
coal
beige
ash

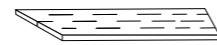

angolo SX
griglia angolo 20x61,0 cm 8"x24" R **RS P107 COPPIA**

ice
gun metal
coal
beige
ash

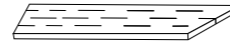

angolo DX

ice
gun metal
coal
beige
ash

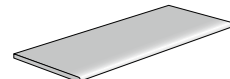

round lineare
30x61,0 cm 12"x24" **RS P110**

ice
gun metal
coal
beige
ash

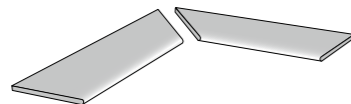

angolo SX
round angolare 30x61,0 cm 12"x24" **RS P119 COPPIA**

ice
gun metal
coal
beige
ash

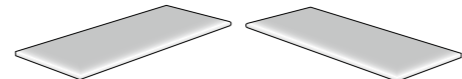

angolo SX
angolo bordo toro 30x61,0 cm 12"x24" **RS P114**

ice
gun metal
coal
beige
ash

Note - Notes - Notes - Anmerkungen

I pezzi speciali FP2 vengono venduti al pezzo e solo su ordinazione (tempo minimo di consegna 20 gg lavorativi dall'ordine).
The special pieces FP2 are sold by piece and only on request (minimum delivery time 20 working days from date of order).
Les pièces spéciales FP2 sont vendus à la pièce et uniquement sur commande (délai minimum de livraison 20 jours ouvrés à partir de la commande).
Spezial Teile FP2 sind pro Stück verkauft und nur auf Bestellungen produziert. (Lieferzeiten mindesten 20 arbeitstage ab Auftragbestätigung)

Per la disponibilità articolo: www.tuscaniagres.it digitando il codice web segnalato a lato dei formati.
For the item's availability: www.tuscaniagres.it type the web code reported next to the sizes.
Pour vérifier la disponibilité de l'article: www.tuscaniagres.it en saisissant le code web indiqué à coté des formats.
Für die Artikelverfügbarkeit: www.tuscaniagres.it web code eingeben, an der Seite von Formaten angedeutet.

beige



L4W8 | 61,0x61,0 cm 24"x24" FP2

RS A198

ash

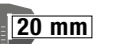

L8X9 | 61,0x61,0 cm 24"x24" FP2

RS A198

ice



L4W9 | 61,0x61,0 cm 24"x24" FP2

RS A198

gun metal



M0R3 | 61,0x61,0 cm 24"x24" FP2

RS A198

coal

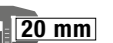

L5W9 | 61,0x61,0 cm 24"x24" FP2

RS A198

Grès porcellanato impasto colorato
Color body porcelain stoneware / Grès cérame coloré dans la masse / Durchgefärbtes Feinsteinzeug

Colori / Colours / Couleurs / Farben



technical project outdoor	effetto pietra stone-look effet pierre steinoptik	HD UGL	V2 MODERATE
----------------------------------	--	-------------------------	---------------------------

RS Rettificato/Strutturato
Rectified/Textured

Formati / Sizes / Formats / Formate

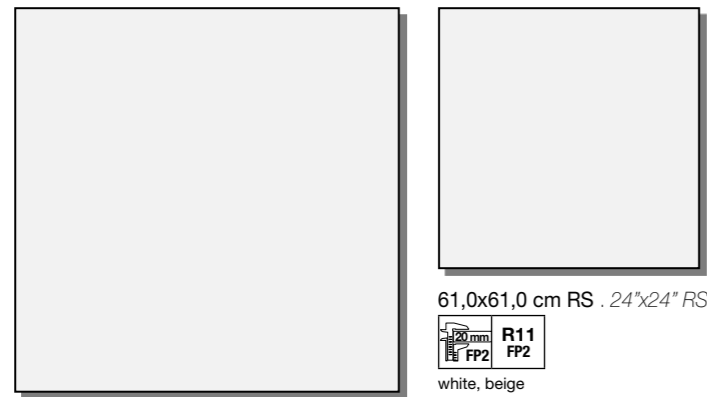

90x90 cm RS . 36"x36" RS

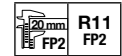

greige, anthracite

61,0x61,0 cm RS . 24"x24" RS

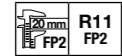

white, beige

BEIGE FP2 | 61,0x61,0 cm RS_24"x24" RS



Per la disponibilità articolo: www.tuscaniagres.it digitando il codice web segnalato a lato dei formati.
For the item's availability: www.tuscaniagres.it type the web code reported next to the sizes.
Pour vérifier la disponibilité de l'article: www.tuscaniagres.it en saisissant le code web indiqué à coté des formats.
Für die Artikelverfügbarkeit: www.tuscaniagres.it web code eingeben, an der Seite von Formaten angedeutet.

white



M7P2|61,0x61,0 cm 24"x24" FP2



beige

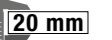

M7P1|61,0x61,0 cm 24"x24" FP2

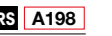

greige



M7P3|90x90 cm 36"x36" FP2



anthracite

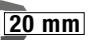

M7P4|90x90 cm 36"x36" FP2

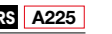

FP2 Pezzi Speciali / Special Pieces / Pièces Spéciales / Formteile

 elemento "L" *45x90x5 cm 18"x36" x2" RS P101 *30x61,0x5 cm 12"x24" x2" RS P100	 angolare elemento "L" *45x90x5 cm 18"x36" x2" RS P104 *30x30x5 cm 12"x12" x2" RS P103	 griglia *20x90 cm 8"x36" RS P118 *20x61,0 cm 8"x24" RS P117	 angolo SX angolo DX griglia angolo *20x90 cm 8"x36" R RS P108 COPPIA *20x61,0 cm 8"x24" R RS P107 COPPIA
<ul style="list-style-type: none"> * white * beige * greige * anthracite 	<ul style="list-style-type: none"> * white * beige * greige * anthracite 	<ul style="list-style-type: none"> * white * beige * greige * anthracite 	<ul style="list-style-type: none"> * white * beige * greige * anthracite
 round lineare *45x90 cm 18"x36" RS P111 *30x61,0 cm 12"x24" RS P110	 angolo SX angolo DX round angolare *45x90 cm 18"x36" RS P120 COPPIA *30x61,0 cm 12"x24" RS P119 COPPIA	 angolo SX angolo DX angolo bordo toro *45x90 cm 18"x36" RS P115 *30x61,0 cm 12"x24" RS P114	<ul style="list-style-type: none"> * white * beige * greige * anthracite
<ul style="list-style-type: none"> * white * beige * greige * anthracite 	<ul style="list-style-type: none"> * white * beige * greige * anthracite 	<ul style="list-style-type: none"> * white * beige * greige * anthracite 	<ul style="list-style-type: none"> * white * beige * greige * anthracite

Note - Notes - Notes - Anmerkungen
I pezzi speciali FP2 vengono venduti al pezzo e solo su ordinazione (tempo minimo di consegna 20 gg lavorativi dall'ordine).
The special pieces FP2 are sold by piece and only on request (minimum delivery time 20 working days from date of order).
Les pièces spéciales FP2 sont vendus à la pièce et uniquement sur commande (délai minimum de livraison 20 jours ouvrés à partir de la commande).
Spezial Teile FP2 sind pro Stück verkauft und nur auf Bestellungen produziert. (Lieferzeiten mindesten 20 arbeitstage ab Auftragbestätigung)

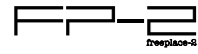

PIERRE BLEUE

Grès porcellanato impasto colorato
Color body porcelain stoneware / Grès cérame coloré dans la masse / Durchgefärbtes Feinsteinzeug

Colori / Colours / Couleurs / Farben



technical project outdoor	effetto pietra stone-look effet pierre steinoptik	HD UGL	V3 HIGH
----------------------------------	--	-------------------	-----------------------

RS Rettificato/Strutturato
Rectified/Textured

Formati / Sizes / Formats / Formate

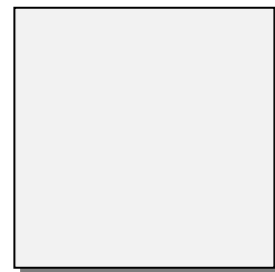

61,0x61,0 cm RS .
24"x24" RS



tutti i colori . all colors .
toutes les couleurs . alle Farben

outdoor: ANTIQUE FP2 | 61,0x61,0 cm RS_24"x24" RS
indoor: FONCÉ | 61,0x61,0 cm R_24"x24" R



Per la disponibilità articolo: www.tuscaniagres.it digitando il codice web segnalato a lato dei formati.
For the item's availability: www.tuscaniagres.it type the web code reported next to the sizes.
Pour vérifier la disponibilité de l'article: www.tuscaniagres.it en saisissant le code web indiqué à coté des formats.
Für die Artikelverfügbarkeit: www.tuscaniagres.it web code eingeben, an der Seite von Formaten angeedeutet.



clair



L1U7 | 61,0x61,0 cm 24"x24" FP2

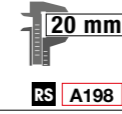

antique



J2Q7 | 61,0x61,0 cm 24"x24" FP2

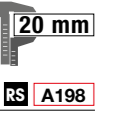

foncé



L1U8 | 61,0x61,0 cm 24"x24" FP2

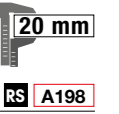

FP2 Pezzi Speciali / Special Pieces / Pièces Spéciales / Formteile

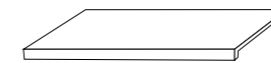

elemento "L"
30x61,0x5 cm 12"x24"x2" **RS P100**
clair
foncé
antique

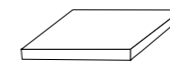

angolare elemento "L"
30x30x5 cm 12"x12"x2" **RS P103**
clair
foncé
antique

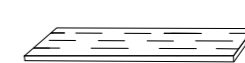

griglia
20x61,0 cm 8"x24" **RS P117**
clair
foncé
antique

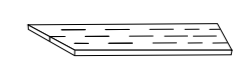

angolo SX
griglia angolo 20x61,0 cm 8"x24" R **RS P107 COPPIA**
clair
foncé
antique

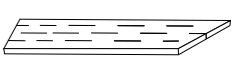

round lineare
30x61,0 cm 12"x24" **RS P110**
clair
foncé
antique

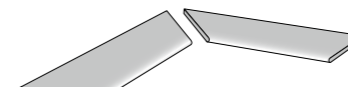

angolo SX
round angolare 30x61,0 cm 12"x24" **RS P119 COPPIA**
clair
foncé
antique

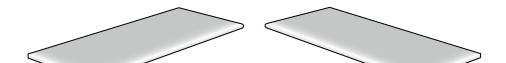

angolo SX
angolo bordo toro 30x61,0 cm 12"x24" **RS P114**
clair
foncé
antique

Note - Notes - Notes - Anmerkungen
I pezzi speciali FP2 vengono venduti al pezzo e solo su ordinazione (tempo minimo di consegna 20 gg lavorativi dall'ordine).
The special pieces FP2 are sold by piece and only on request (minimum delivery time 20 working days from date of order).
Les pièces spéciales FP2 sont vendus à la pièce et uniquement sur commande (délai minimum de livraison 20 jours ouvrés à partir de la commande).
Spezial Teile FP2 sind pro Stück verkauft und nur auf Bestellungen produziert. (Lieferzeiten mindesten 20 arbeitstage ab Auftragbestätigung)

Grès porcellanato impasto colorato
Color body porcelain stoneware / Grès cérame coloré dans la masse / Durchgefärbtes Feinsteinzeug

Colori / Colours / Couleurs / Farben

medium



technical project outdoor	effetto pietra stone-look effet pierre steinoptik	HD UGL	V4 RANDOM
----------------------------------	--	-------------------------	--------------------------------

RS Rettificato/Strutturato
Rectified/Textured

Formati / Sizes / Formats / Formate

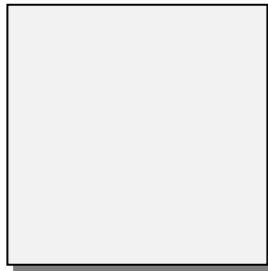

61,0x61,0 cm RS .
24"x24" RS

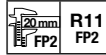

tutti i colori . all colors .
toutes les couleurs . alle Farben

MEDIUM FP2 | 61,0x61,0 cm RS_24"x24" RS



Per la disponibilità articolo: www.tuscaniagres.it digitando il codice web segnalato a lato dei formati.
For the item's availability: www.tuscaniagres.it type the web code reported next to the sizes.
Pour vérifier la disponibilité de l'article: www.tuscaniagres.it en saisissant le code web indiqué à coté des formats.
Für die Artikelverfügbarkeit: www.tuscaniagres.it web code eingeben, an der Seite von Formaten angedeutet.

medium



I4Z2 | 61,0x61,0 cm 24"x24" FP2

RS **A198**

FP2 Pezzi Speciali / Special Pieces / Pièces Spéciales / Formteile

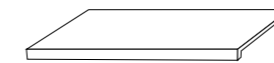

elemento "L"
30x61,0x5 cm 12"x24"x2" **RS** **P100**
medium

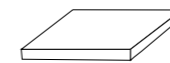

angolare elemento "L"
30x30x5 cm 12"x12"x2" **RS** **P103**
medium

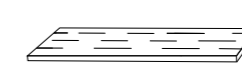

griglia
20x61,0 cm 8"x24" **RS** **P117**
medium



angolo SX
griglia angolo 20x61,0 cm 8"x24" R **RS** **P107 COPPIA**
medium

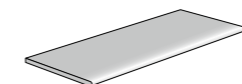
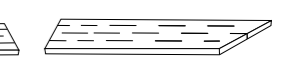

round lineare
30x61,0 cm 12"x24" **RS** **P110**
medium

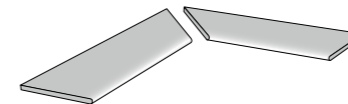

angolo SX
round angolare 30x61,0 cm 12"x24" **RS** **P119 COPPIA**
medium

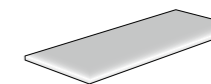

angolo SX
angolo bordo toro 30x61,0 cm 12"x24" **RS** **P114**
medium

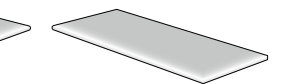

Note - Notes - Notes - Anmerkungen
I pezzi speciali FP2 vengono venduti al pezzo e solo su ordinazione (tempo minimo di consegna 20 gg lavorativi dall'ordine).
The special pieces FP2 are sold by piece and only on request (minimum delivery time 20 working days from date of order).
Les pièces spéciales FP2 sont vendus à la pièce et uniquement sur commande (délai minimum de livraison 20 jours ouvrés à partir de la commande).
Spezial Teile FP2 sind pro Stück verkauft und nur auf Bestellungen produziert. (Lieferzeiten mindesten 20 arbeitstage ab Auftragbestätigung)

Grès porcellanato
Porcelain stoneware / Grès cérame / Feinsteinzeug

Colori / Colours / Couleurs / Farben



technical project outdoor	effetto marmo marble-look effet marbre marmoroptik	HD UGL	V2 MODERATE
----------------------------------	---	-------------------------	---------------------------

RS Rettificato/Strutturato
Rectified/Textured

Formati / Sizes / Formats / Formate

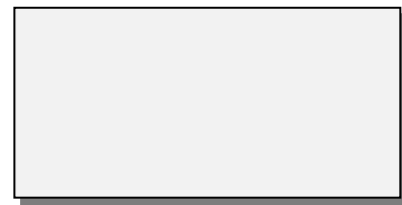

45x90 cm RS
18"x36" RS



tutti i colori . all colors .
toutes les couleurs . alle Farben

SILVER FP2 | 45x90 cm RS_18"x36" RS



Per la disponibilità articolo: www.tuscaniagres.it digitando il codice web segnalato a lato dei formati.
For the item's availability: www.tuscaniagres.it type the web code reported next to the sizes.
Pour vérifier la disponibilité de l'article: www.tuscaniagres.it en saisissant le code web indiqué à coté des formats.
Für die Artikelverfügbarkeit: www.tuscaniagres.it web code eingeben, an der Seite von Formaten angedeutet.

white



M2S1 | 45x90 cm 18"x36" FP2 **RS** **A171**

silver



M2S0 | 45x90 cm 18"x36" FP2 **RS** **A171**

bone



M1S9 | 45x90 cm 18"x36" FP2 **RS** **A171**

FP2 Pezzi Speciali / Special Pieces / Pièces Spéciales / Formteile

 elemento "L" 45x90x5 cm 18"x36" x2" RS P101 white _____ silver _____ bone _____	 angolare elemento "L" 45x90x5 cm 18"x36" x2" RS P104 white _____ silver _____ bone _____	 griglia 20x90 cm 8"x36" RS P118 white _____ silver _____ bone _____	 angolo SX griglia angolo 20x90 cm 8"x36" RS P108 COPPIA white _____ silver _____ bone _____
 round lineare 45x90 cm 18"x36" RS P111 white _____ silver _____ bone _____	 angolo SX round angolare 45x90 cm 18"x36" RS P120 COPPIA white _____ silver _____ bone _____	 angolo SX angolo DX angolo bordo toro 45x90 cm 18"x36" RS P115 white _____ silver _____ bone _____	

Note - Notes - Notes - Anmerkungen
 I pezzi speciali FP2 vengono venduti al pezzo e solo su ordinazione (tempo minimo di consegna 20 gg lavorativi dall'ordine).
 The special pieces FP2 are sold by piece and only on request (minimum delivery time 20 working days from date of order).
 Les pièces spéciales FP2 sont vendus à la pièce et uniquement sur commande (délai minimum de livraison 20 jours ouvrés à partir de la commande).
 Spezial Teile FP2 sind pro Stück verkauft und nur auf Bestellungen produziert. (Lieferzeiten mindesten 20 arbeitstage ab Auftragbestätigung)

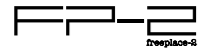

NORTH WIND

Grès porcellanato
Porcelain stoneware / Grès cérame / Feinsteinzeug

Colori / Colours / Couleurs / Farben



technical project outdoor	effetto legno wood-look effet bois holzoptik	HD UGL	V3 HIGH
----------------------------------	---	-------------------------	-----------------------

RS Rettificato/Strutturato
Rectified/Textured

Formati / Sizes / Formats / Formate



45x90 cm RS .
18"x36" RS



tutti i colori . all colors .
toutes les couleurs . alle Farben



40x122 cm RS .
16"x48" RS

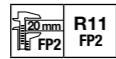

tutti i colori . all colors .
toutes les couleurs . alle Farben

MELANGE FP2 | 45x90 cm RS_18"x36" RS

GREY FP2 | 40x122 cm RS_16"x48" RS



Per la disponibilità articolo: www.tuscaniagres.it digitando il codice web segnalato a lato dei formati.
For the item's availability: www.tuscaniagres.it type the web code reported next to the sizes.
Pour vérifier la disponibilité de l'article: www.tuscaniagres.it en saisissant le code web indiqué à coté des formats.
Für die Artikelverfügbarkeit: www.tuscaniagres.it web code eingeben, an der Seite von Formaten angedeutet.



grey



I7E7 | 45x90 cm 18"x36" FP2

RS **A171**

L7U8 | 40x122 cm 16"x48" FP2

RS **A150**

brown

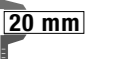

I7E4 | 45x90 cm 18"x36" FP2

RS **A171**

L7U7 | 40x122 cm 16"x48" FP2

RS **A150**

melange

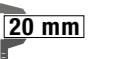

I7E6 | 45x90 cm 18"x36" FP2

RS **A171**

L7U9 | 40x122 cm 16"x48" FP2

RS **A150**

FP2 Pezzi Speciali / Special Pieces / Pièces Spéciales / Formteile

*Griglia e griglia angolo 20x61 cm abbinare al formato 40x122 cm.
Grille and corner grille 8"x24" combined with the 16"x48" size.



elemento "L"

45x90x5 cm 18"x36" x2" **RS** **P101**
40x122x5 cm 16"x48" x2" **RS** **P102**

grey

brown

melange

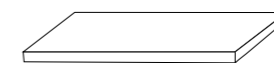

angolare elemento "L"

45x90x5 cm 18"x36" x2" **RS** **P104**
40x122x5 cm 16"x48" x2" **RS** **P105**

grey

brown

melange

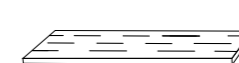

griglia

20x90 cm 8"x36" **RS** **P118**
*20x61,0 cm 8"x24" **RS** **P106**

grey

brown

melange

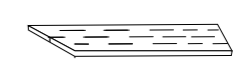

angolo SX

griglia angolo
20x90 cm 8"x36" **RS** **P108 COPPIA**
*20x61,0 cm 8"x24" **RS** **P109 COPPIA**

grey

brown

melange

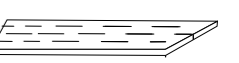

angolo DX

griglia angolo
20x90 cm 8"x36" **RS** **P108 COPPIA**
*20x61,0 cm 8"x24" **RS** **P109 COPPIA**

grey

brown

melange

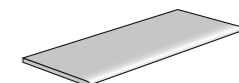

round lineare

45x90 cm 18"x36" **RS** **P111**
40x122 cm 16"x48" **RS** **P112**

grey

brown

melange



round angolare

45x90 cm 18"x36" **RS** **P120 COPPIA**
40x122 cm 16"x48" **RS** **P113 COPPIA**

grey

brown

melange

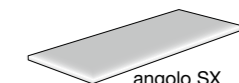

angolo bordo toro

45x90 cm 18"x36" **RS** **P115**
40x122 cm 16"x48" **RS** **P116**

grey

brown

melange

Note - Notes - Notes - Anmerkungen
I pezzi speciali FP2 vengono venduti al pezzo e solo su ordinazione (tempo minimo di consegna 20 gg lavorativi dall'ordine).
The special pieces FP2 are sold by piece and only on request (minimum delivery time 20 working days from date of order).
Les pièces spéciales FP2 sont vendus à la pièce et uniquement sur commande (délai minimum de livraison 20 jours ouvrés à partir de la commande).
Spezial Teile FP2 sind pro Stück verkauft und nur auf Bestellungen produziert. (Lieferzeiten mindesten 20 arbeitstage ab Auftragbestätigung)

Grès porcellanato
Porcelain stoneware / Grès cérame / Feinsteinzeug

Colori / Colours / Couleurs / Farben



technical project outdoor	effetto legno wood-look effet bois holzoptik	HD UGL	V3 HIGH
----------------------------------	---	-------------------------	------------------------------

RS Rettificato/Strutturato
Rectified/Textured

Formati / Sizes / Formats / Formate

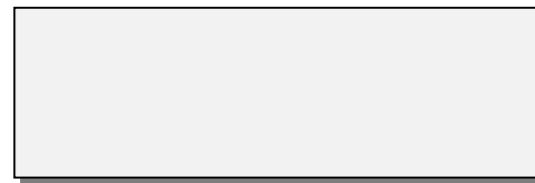

40x122 cm RS .
16"x48" RS



tutti i colori . all colors .
toutes les couleurs . alle Farben

Per la disponibilità articolo: www.tuscaniagres.it digitando il codice web segnalato a lato dei formati.
For the item's availability: www.tuscaniagres.it type the web code reported next to the sizes.
Pour vérifier la disponibilité de l'article: www.tuscaniagres.it en saisissant le code web indiqué à coté des formats.
Für die Artikelverfügbarkeit: www.tuscaniagres.it web code eingeben, an der Seite von Formaten angedeutet.

miele



L6U1 | 40x122 cm 16"x48" FP2



RS **A150**

noce



L6U2 | 40x122 cm 16"x48" FP2



RS **A150**

NOCE FP2 | 40x122 cm RS_16"x48" RS



FP2 Pezzi Speciali / Special Pieces / Pièces Spéciales / Formteile

*Griglia e griglia angolo 20x61 cm abbinare al formato 40x122 cm.
Grille and corner grille 8"x24" combined with the 16"x48" size.

 elemento "L" 40x122x5 cm 16"x48" x2" RS P102 miele _____ noce _____	 angolare elemento "L" 40x122x5 cm 16"x48" x2" RS P105 miele _____ noce _____	 griglia *20x61,0 cm 8"x24" RS P106 miele _____ noce _____	 angolo SX griglia angolo *20x61,0 cm 8"x24" RS P109 COPPIA miele _____ noce _____	 angolo DX RS P109 COPPIA miele _____ noce _____
 round lineare 40x122 cm 16"x48" RS P112 miele _____ noce _____	 round angolare 40x122 cm 16"x48" RS P113 COPPIA miele _____ noce _____	 angolo SX angolo DX angolo bordo toro 40x122 cm 16"x48" RS P116 miele _____ noce _____	 angolo SX angolo DX RS P116 miele _____ noce _____	

Note - Notes - Notes - Anmerkungen
 I pezzi speciali FP2 vengono venduti al pezzo e solo su ordinazione (tempo minimo di consegna 20 gg lavorativi dall'ordine).
 The special pieces FP2 are sold by piece and only on request (minimum delivery time 20 working days from date of order).
 Les pièces spéciales FP2 sont vendus à la pièce et uniquement sur commande (délai minimum de livraison 20 jours ouvrés à partir de la commande).
 Spezial Teile FP2 sind pro Stück verkauft und nur auf Bestellungen produziert. (Lieferzeiten mindesten 20 arbeitstage ab Auftragbestätigung)

Grès porcellanato
Porcelain stoneware / Grès cérame / Feinsteinzeug

Colori / Colours / Couleurs / Farben

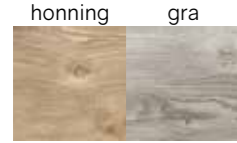

technical project outdoor	effetto legno wood-look effet bois holzoptik	HD UGL	V3 HIGH
----------------------------------	---	-------------------------	------------------------------

RS Rettificato/Strutturato
Rectified/Textured

Formati / Sizes / Formats / Formate



40x122 cm RS .
16"x48" RS

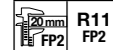

tutti i colori . all colors .
toutes les couleurs . alle Farben

HONNING FP2 | 40x122 cm RS_16"x48" RS



Per la disponibilità articolo: www.tuscaniagres.it digitando il codice web segnalato a lato dei formati.
For the item's availability: www.tuscaniagres.it type the web code reported next to the sizes.
Pour vérifier la disponibilité de l'article: www.tuscaniagres.it en saisissant le code web indiqué à coté des formats.
Für die Artikelverfügbarkeit: www.tuscaniagres.it web code eingeben, an der Seite von Formaten angedeutet.

honning



L7U1 | 40x122 cm 16"x48" FP2



RS **A150**

gra



L7U0 | 40x122 cm 16"x48" FP2



RS **A150**

FP2 Pezzi Speciali / Special Pieces / Pièces Spéciales / Formteile

*Griglia e griglia angolo 20x61 cm abbinata al formato 40x122 cm.
Grille and corner grille 8"x24" combined with the 16"x48" size.

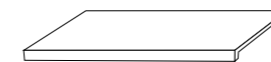

elemento "L"
40x122x5 cm 16"x48" x2" **RS** **P102**
honning _____
gra _____

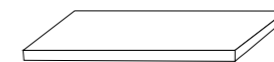

angolare elemento "L"
40x122x5 cm 16"x48" x2" **RS** **P105**
honning _____
gra _____



griglia
*20x61,0 cm 8"x24" **RS** **P106**
honning _____
gra _____

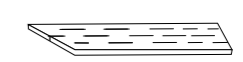

angolo SX
griglia angolo
*20x61,0 cm 8"x24" **RS** **P109 COPPIA**
honning _____
gra _____

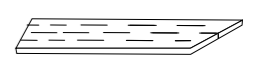

angolo DX
RS **P109 COPPIA**
honning _____
gra _____

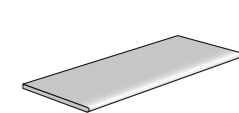

round lineare
40x122 cm 16"x48" **RS** **P112**
honning _____
gra _____

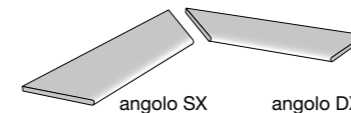

angolo SX angolo DX
round angolare
40x122 cm 16"x48" **RS** **P113 COPPIA**
honning _____
gra _____

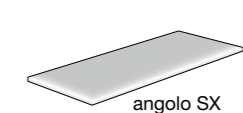

angolo SX angolo DX
angolo bordo toro
40x122 cm 16"x48" **RS** **P116**
honning _____
gra _____

Note - Notes - Notes - Anmerkungen
I pezzi speciali FP2 vengono venduti al pezzo e solo su ordinazione (tempo minimo di consegna 20 gg lavorativi dall'ordine).
The special pieces FP2 are sold by piece and only on request (minimum delivery time 20 working days from date of order).
Les pièces spéciales FP2 sont vendus à la pièce et uniquement sur commande (délai minimum de livraison 20 jours ouvrés à partir de la commande).
Spezial Teile FP2 sind pro Stück verkauft und nur auf Bestellungen produziert. (Lieferzeiten mindesten 20 arbeitstage ab Auftragbestätigung)



Tabella pesi ed imballi / Sizes weight and packaging /
Mesures poids et emballages / Tabelle der Gewichte und Verpackungen /

formati / sizes / tailles / formate /		pz. x box	mq. x box	kg. x box	box x pal.	mq. x pal.	kg. x pal.	
122x122 cm 48"x48" FP2 (rettificato)	20 mm	1	1,49	64,02	18	26,82	1192	135x135x55
90x90 cm 36"x36" FP2 (rettificato)	20 mm	1	0,81	33,86	21	17,01	731	94x107x64
61,0x122 cm 24"x48" FP2 (rettificato)	20 mm	1	0,74	31,80	36	26,64	1160	80x120x75
61,0x61,0 cm 24"x24" FP2 (rettificato)	20 mm	2	0,74	30,94	30	22,20	950	80x120x75
45x90 cm 18"x36" FP2 (rettificato)	20 mm	2	0,81	33,86	27	21,87	932	100x120x55
40x122 cm 16"x48" FP2 (rettificato)	20 mm	2	0,98	40,66	21	20,58	880	94x120x55

Note - Notes - Notes - Anmerkungen

I pezzi speciali FP2 vengono venduti al pezzo e solo su ordinazione (tempo minimo di consegna 20 gg lavorativi dall'ordine).

The special pieces FP2 are sold by piece and only on request (minimum delivery time 20 working days from date of order).

Les pièces spéciales FP2 sont vendus à la pièce et uniquement sur commande (délai minimum de livraison 20 jours ouvrés à partir de la commande).

Spezial Teile FP2 sind pro Stück verkauft und nur auf Bestellungen produziert. (Lieferzeiten mindesten 20 arbeitstage ab Auftragbestätigung)

Simbologia caratteristiche tecniche - grès porcellanato / Symboles technical characteristics - porcelain stoneware /
Symboles des caractéristiques techniques - grès cérame / Symbole technischen eigenschaften - feinsteinzeug /

	CARATTERISTICHE TECNICHE TECHNICAL CHARACTERISTICS CARACTÉRISTIQUES TECHNIQUES TECHNISCHE MERKMALE	NORMA DI RIFERIMENTO REFERENCE STANDARD NORME DE REFERENCE PRÜFMETHODE	VALORE RICHIESTO REQUIRED VALUE VALEUR REQUISE SOLLWERT	VALORE MEDIO TUSCANIA AV. TUSCANIA VALUE VALEUR MOYENNE TUSCANIA MITTLERER TUSCANIA-WERT
	DIMENSIONI DIMENSIONS DIMENSIONS ABMESSUNGEN	ISO 10545-2	CONFORME COMPLIANT CONFORME KONFORM	CONFORME COMPLIANT CONFORME KONFORM
	ASSORBIMENTO D'ACQUA WATER ABSORPTION ABSORPTION D'EAU WASSERAUFNAHME	ISO 10545-3	≤ 0,5 %	CONFORME COMPLIANT CONFORME KONFORM
	RESISTENZA A FLESSIONE MODULUS OF RUPTURE RESISTANCE A LA FLEXION BIEGEFESTIGKEIT	ISO 10545-4	MODULUS OF RUPTURE R ≥ 35 N/MM ² BREAKING STRENGTH S ≥ 1300 N	CONFORME COMPLIANT CONFORME KONFORM
	RESISTENZA ALL'ABRASIONE ABRASION RESISTANCE RÉSISTANCE À L'ABRASION ABRIEBBESTÄNDIGKEIT	ISO 10545-7	PEI	IV / V
	DILATAZIONE TERMICA LINEARE LINEAR THERMAL EXPANSION DILATATION THERMIQUE LINEAIRE LINEARE WÄRMEAUSSDEHNUNG	ISO 10545-8	≤ 9x10 ⁻⁵ °C ⁻¹	CONFORME COMPLIANT CONFORME KONFORM
	RESISTENZA AGLI SBALZI TERMICI THERMAL SHOCK RESISTANCE RESISTANCE AUX ECARTS DE TEMPERATURE ITEMPERATURWECHSELBESTÄNDIGKEIT	ISO 10545-9	RESISTENTE RESISTANT RESISTANT BESTÄNDIG	RESISTENTE RESISTANT RESISTANT BESTÄNDIG
	RESISTENZA AL GELO FROST RESISTANCE RESISTANCE AU GEL FROSTBESTÄNDIGKEIT	ISO 10545-12	RESISTENTE RESISTANT RESISTANT BESTÄNDIG	RESISTENTE RESISTANT RESISTANT BESTÄNDIG
	RESISTENZA AGLI ACIDI ED ALLE BASI ACID AND ALKALI RESISTANCE RESISTANCE AUX ACIDES ET AUX BASES SÄURE- UND LAUGENBESTÄNDIGKEIT	ISO 10545-13	CLASS GB MIN.	LOW CONCENTRATION GLA HIGH CONCENTRATION GHA
	RESISTENZA ALL'ATTACCO CHIMICO CHEMICAL RESISTANCE RESISTANCE À L'ATTAQUE CHEMIQUE CHEMISCHE BESTÄNDIGKEIT	ISO 10545-13	CLASS GB MIN.	GA
	RESISTENZA ALLE MACCHIE STAIN RESISTANCE RESISTANCE AU TACHES FLECKENBESTÄNDIGKEIT	ISO 10545-14	CLASS 3 MIN.	5
	COEFFICIENTE DI ATTRITO (SCIOLIOSITÀ) FRICTION COEFFICIENT (SLIPPERINESS) COEFFICIENT DE FRICTION (GLISSEMENT) REIBUNGSKOEFFIZIENT (RUTSCHIGKEIT)	BCR - ITALIA DM DEL 14-06-89 DRY RUBBER 0,65 WET RUBBER 0,51 DRY LEATHER 0,62	ASTM - USA ASTM C1028 DRY NEOLYTHE 0,69 WET NEOLYTHE 0,62	DIN - GERMANIA DIN 51130 R11 ZH 1/571
THE PRODUCTS HAVING AN ABSORPTION < 0,5% ARE CLASSIFIED ACCORDING THE UNI CEN STANDARDS "FULLY VITRIFIED TILES" AND ACCORDING TO THE ASTM STANDARDS "IMPERVIOUS TILES"				



Le informazioni contenute nel presente catalogo sono il più possibile esatte, ma non sono da ritenersi vincolanti. Per esigenze di produzione l'Azienda si riserva il diritto di apportare eventuali modifiche che si rendessero necessarie.

Peso, colori e misure sono soggetti alle inevitabili variazioni tipiche del processo di cottura della ceramica. Il colori e gli effetti riportati sul presente catalogo sono indicativi per i limiti consentiti dalla stampa; per questo non possono essere vincolanti e costituire base per eventuali contestazioni.

The information contained in this catalogue is as accurate as possible, but cannot be considered as legally binding. The Company reserves the right to make any modifications that become necessary due to production requirements.

Weight, colours and dimensions are subject to the inevitable variations typical of the ceramic firing process. Colours and aesthetic effects shown on this catalogue should be considered indicative and approximate as a result of printing process limits. Possible variations may occur and can not be at the base of any claim.

Les informations reprises dans ce catalogue sont exactes, mais elles n'engagent aucunement notre Société du point de vue légal. Pour des exigences de production la Société se réserve le droit d'apporter toutes les dimensions sont assujettis aux variations typiques du processus de cuisson de la céramiques.

Les couleurs et les effets présentés dans ce catalogue sont indicatifs dans la mesure permise par la presse, ce qui explique pourquoi ils ne peuvent pas être obligatoire et constituer la base d'un éventuel désaccord.

Die Informationen des vorliegenden Katalogs sind so exakt wie möglich, sind jedoch nicht als gesetzlich verbindlich zu betrachten. Aus Fertigungsgründen behält die Firma sich das Recht vor, eventuell notwendige Änderungen vorzunehmen. Gewicht, Farben und Abmessungen unterliegen den unvermeidlichen Veränderungen, die für den Brennvorgang von Keramikprodukten typisch sind. Die in diesem Katalog gezeigten Farben und Effekte sind Richtwerte, soweit durch die Presse, die ist, warum sie nicht bindend und stellen die Grundlage für eine Meinungsverschiedenheit gestattet.

Credit:

Marketing:
Tuscania

Progetto Grafico:
EUREKA

stampa:
Artestampa Fioranese

finito di stampare:
Luglio 2020



Tuscania S.p.A.
Via Giardini Sud, 4603
41028 Serramazzoni (Mo) - Italia
Tel. +39 0536.952399
Fax +39 0536.954716
info@tuscaniagres.it
www.tuscaniagres.it



放射性水平A类



FP2
TECHNICAL
PROJECT/



tuscaniagres.it