

MADE IN ITALY

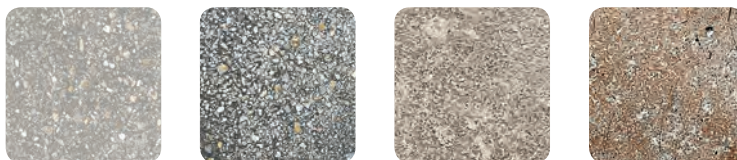

# Pavé 3.0

22,5x45 - 22,5x22,5



**GRES PORCELLANATO**  
PORCELAIN STONEWARE . GRÈS CÉRAME . FEINSTEINZEUG

**richenia**  
ECCELLENZA CERAMICA ITALIANA



**PAVÉ 3.0 IS TIMELESS MODERNITY.**  
The starting point is tradition, a rustic and classic taste bearing in mind current needs. The result is warm and welcoming atmospheres

**PAVÉ 3.0 EST SYNONYME D'UNE**  
contemporanéité hors du temps dont le point de départ est la tradition, un style rustique et classique modelé à la lumière des exigences du présent. Il en résulte des espaces chauds et accueillants.

**PAVÉ 3.0 IST ZEITLOSE MODERNITÄT:**  
der Ausgangspunkt ist die Tradition, ein rustikaler und klassischer Stil, der im Licht der Erfordernisse der Gegenwart geformt wird. Das Ergebnis sind warme und gemütliche Räume.





---

# Pavé 3.0

---

**Pavé 3.0 è contemporaneità senza tempo: il punto di partenza è la tradizione, un gusto rustico e classico plasmato alla luce delle esigenze del presente. Il risultato si traduce in ambienti caldi e accoglienti.**



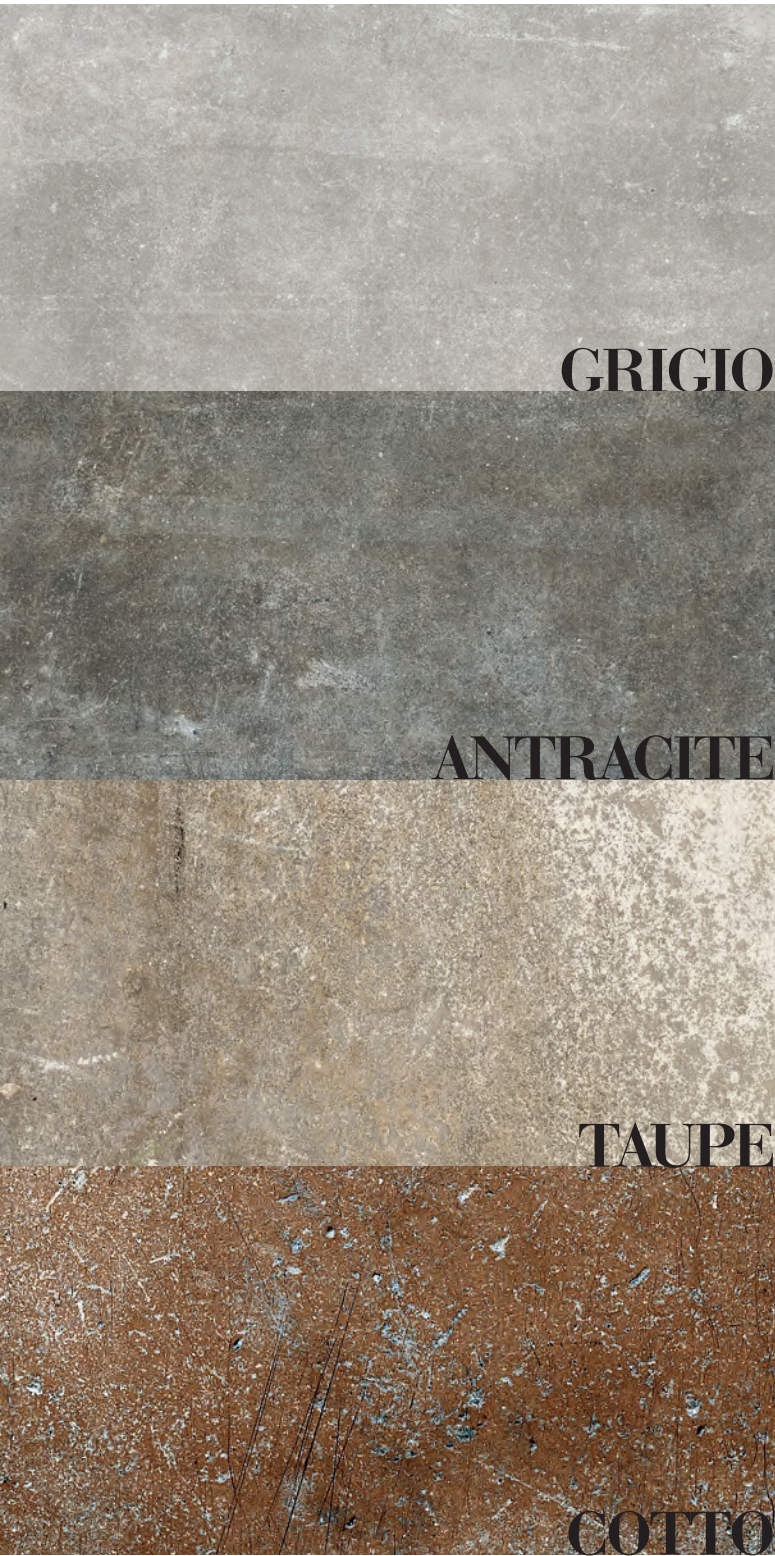

**GRIGIO**

**ANTRACITE**

**TAUPE**

**COTTO**

## **4 Colori 2 Formati**

4 colours / 2 sizes  
4 couleurs / 2 formats  
4 farben / 2 formate

**22,5x45  
22,5x22,5**



GRIGIO  
BAGNO / BATHROOM  
SALLE DE BAIN / BAD

08



GRIGIO  
CUCINA / KITCHEN  
CUISINE / KÜCHE

12



ANTRACITE  
CAMERA / BEDROOM  
CHAMBRE / SCHLAFZIMMER

16



18

ANTRACITE  
OUTDOOR / OUTDOOR  
DE PLEIN AIR / AUSSENBEREICH

COTTO  
LIVING / LIVING  
VIVANT / WOHNBEREICH

21



29

TAUPE  
LIVING / LIVING  
VIVANT / WOHNBEREICH



22

COTTO  
CUCINA / KITCHEN  
CUISINE / KÜCHE



**Il gusto della tradizione  
reinterpretato alla luce  
della contemporaneità**

**/**

**The taste of tradition  
reinterpreted bearing in  
mind modernity**



Cementina B Grigio 22,5x22,5



Le grafiche moderne nascono da un sofisticato mélange di superfici cementizie e lapidee declinate in quattro raffinate e contemporanee nuance - grigio, antracite, taupe e cotto.

Modern graphics coming from a sophisticated mélange of concrete and stone surfaces are declined in four refined and contemporary nuances: grigio, antracite, taupe and cotto.

Les graphismes modernes naissent d'un mélange sophistiqué de surfaces à base de ciment et de pierres déclinées en quatre nuances raffinées et contemporaines : gris, anthracite, taupe et cotto.

Die modernen Grafiken gehen aus einer innovativen Mischung aus Oberflächen aus Zement und Stein in vier verschiedenen modernen Nuancen hervor - Grau, Anthrazit, Taupe und Terrakotta.



PAVIMENTO . FLOOR / Grigio 22,5x22,5

/ Grigio 22,5x45

/ Cementine Mix Grigio 22,5x22,5

RIVESTIMENTO . WALL / Pavé Wall bianco 16,5x41



PAVIMENTO . FLOOR / Grigio 22,5x22,5 . Cementina Blend Grigio 22,5x22,5

RIVESTIMENTO . WALL / Cementina Blend Grigio 22,5x22,5









PAVIMENTO . FLOOR / Grigio 22,5x45





Pavé 3.0 si materializza nei formati 22,5x45 e 22,5x22,5 capaci di garantire versatili schemi di posa, e negli elementi decorativi frutto della reinterpretazione delle tradizionali cementine.

Pavé 3.0 materializes in 22.5x45 and 22.5x22.5 sizes, which are always able to guarantee different tile laying solutions, as well as decorative elements coming from a modern reinterpretation of traditional Italian "cementine".

Pavé 3.0 se matérialise dans les formats 22,5x45 et 22,5x22,5 capables de garantir des schémas de pose polyvalents et dans des éléments décoratifs dérivant de la réinterprétation des carreaux-ciment traditionnels.

Pavé 3.0 ist in den Formaten 22,5x45 und 22,5x22,5, verfügbare und als Dekorelemente erhältlich. Diese Kollektion ist das Ergebnis der Neuinterpretation der traditionellen Zementfliesen und ermöglicht vielseitige Anwendungsmöglichkeiten.









PAVIMENTO . FLOOR / Grigio 22,5x45  
/ Grigio 22,5x22,5  
/ Cementine Blend Grigio 22,5x22,5







**La carica emotiva delle  
superfici diventa fonte di  
ispirazione estetica**

**The emotional power of  
surfaces becomes source  
of aesthetic inspiration**

Antracite 22,5x22,5 . Cementina B Antracite 22,5x22,5





PAVIMENTO . FLOOR / Antracite 22,5x22,5  
/ Antracite 22,5x45  
/ Cementine Blend Antracite 22,5x22,5







PAVIMENTO . FLOOR / Antracite 22,5x45  
/ Antracite 22,5x22,5





**OUT  
DOOR**









Formati, colori, grafiche e decori conferiscono ad ogni ambiente un senso di originalità e di piacevolezza, quale perfetta sintesi tra tradizione e contemporaneità

Sizes, colors, graphics and decors give each room a sense of originality and pleasantness, as a perfect synthesis between tradition and modernity

Les formats, les couleurs, les graphismes et les décors confèrent à chaque espace une idée d'originalité et d'esthétique, qui représente la synthèse parfaite entre la tradition et la contemporanéité.

Formaten, Farben, Graphiken und Dekoren verleihen jeden Raum eine originelle und angenehme Atmosphäre, Synthese zwischen Tradition und Modernität eine Spur Originalität und Annehmlichkeit.



Cementina A Cotto 22,5x22,5



**Le tradizionali  
cementine rivisitate  
in chiave moderna  
diventano elementi  
decorativi**

**/**

**Decors revisit  
traditional Italian  
“cementine” with a  
modern twist**



PAVIMENTO . FLOOR / Cotto 22,5x45  
/ Cotto 22,5x22,5

PAVÉ 3.0

Cotto







RIVESTIMENTO . WALL / Cementina C Cotto 22,5x22,5



PAVÉ 3.0

Cotto







RIVESTIMENTO . WALL / Cementine Blend Cotto 22,5x22,5

PAVIMENTO . FLOOR / Cotto 22,5x45



PAVÉ 3.0

Cotto







PAVIMENTO . FLOOR / Cotto 22,5x22,5  
/ Cotto 22,5x45

OUT  
DOOR

Cotto — PAVÉ 3.0



**Perfetta  
sintesi tra  
contemporaneità  
e tradizione**

**/  
Perfect synthesis  
between  
modernity and  
tradition**



Taupe 22,5x22,5 - Cementine Blend Taupe 22,5x22,5



PAVIMENTO . FLOOR / Taupe 22,5x22,5  
/ Cementina D Taupe 22,5x22,5









PAVIMENTO . FLOOR / Essenze Rovere 20x120  
/ Cementine Blend Taupe 22,5x22,5







OUT  
DOOR



PAVIMENTO . FLOOR / Taupe 22,5x22,5  
/ Taupe 22,5x45











PAVIMENTO . FLOOR / Taupe 22,5x22,5

RIVESTIMENTO . WALL / Cementine Blend Taupe 22,5x22,5



**IN**  
**DOOR**





# OUT DOOR



INDOOR / Taupe 22,5x45  
OUTDOOR / Taupe 22,5x45 . 22,5x22,5

Taupe — PAVÉ 3.0



## SCHEMI DI POSA

Laying patterns - Modèles de pose- Verlegeschema

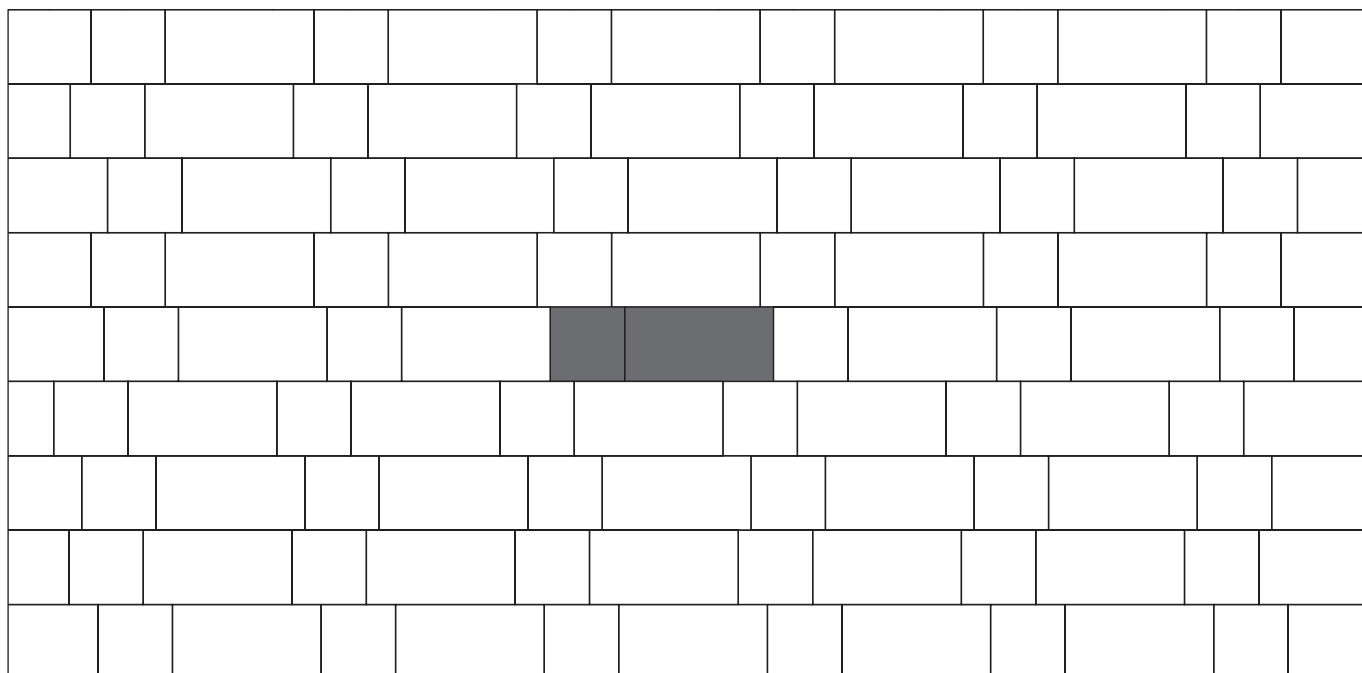

cm	22,5 x 45	22,5 x 22,5			
inch	9"x 18"	9"x 9"			
% mq	66,67%	33,33%			

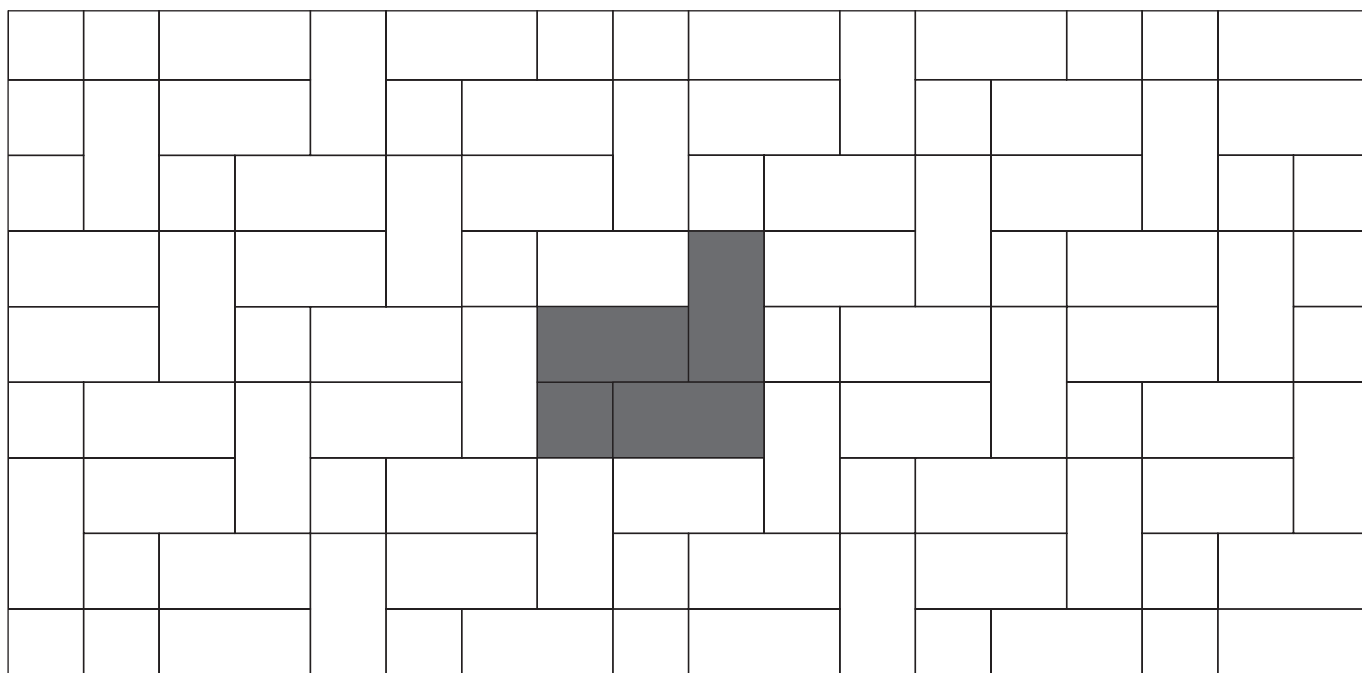

cm	22,5 x 45	22,5 x 22,5			
inch	9"x 18"	9"x 9"			
% mq	85,71%	14,29%			



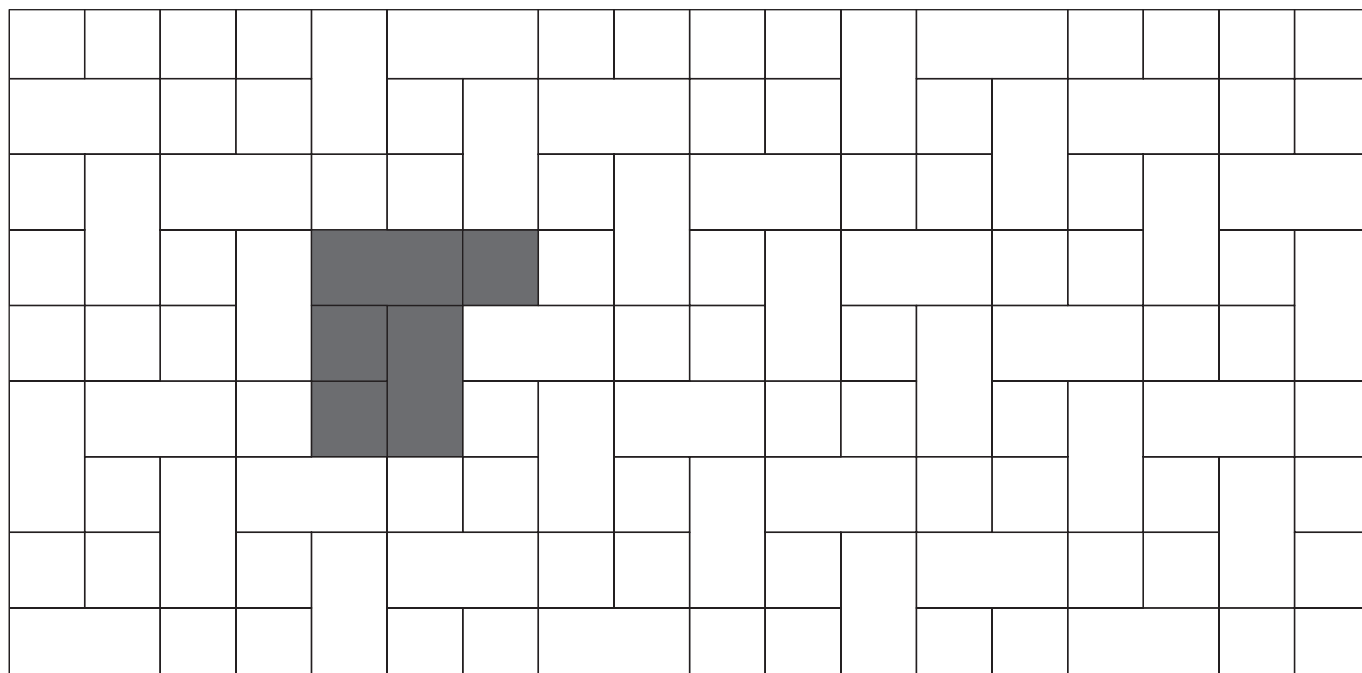

cm	22,5 x 45	22,5 x 22,5			
inch	9"x 18"	9"x 9"			
% mq	66,67%	33,33%			

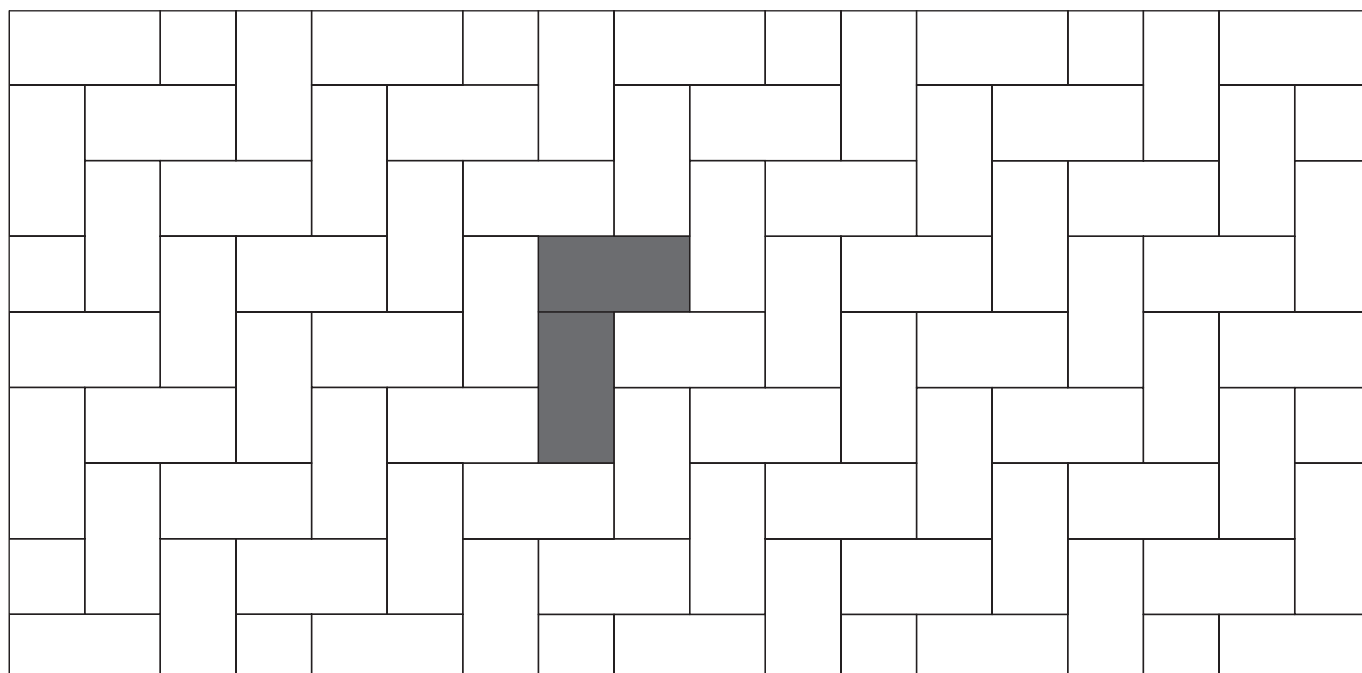

cm	22,5 x 45				
inch	9"x 18"				
% mq	100,00%				



# Pavé 3.0

GRES PORCELLANATO . PORCELAIN STONEWARE . GRÈS CÉRAME . FEINSTEINZEUG

22,5x45 | 22,5x22,5  
9" x 18" | 9" x 9"

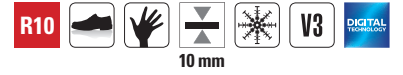

## GRIGIO

indoor



180671 - 22,5x45

50



180681 - 22,5x22,5

50



180711 - 22,5x22,5 Cementina Blend (16 Pz)

55



180721 - 22,5x22,5  
Cementina A

55

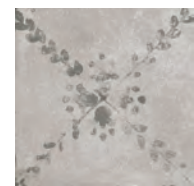
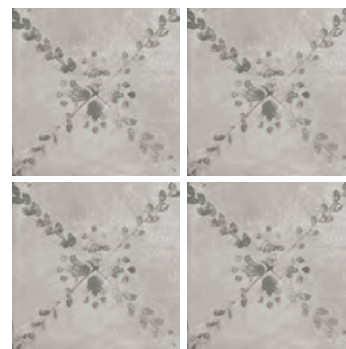

180821 - 22,5x22,5  
Cementina B

55



180831 - 22,5x22,5  
Cementina C

55



180841 - 22,5x22,5  
Cementina D

55





10 mm

**ANTRACITE**

*indoor*

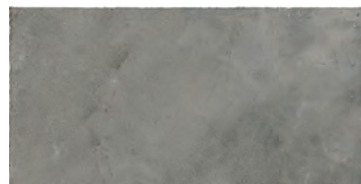

**180674** - 22,5x45

50



**180684** - 22,5x22,5

50



**180714** - 22,5x22,5 Cementina Blend (16 Pz)

55



**180724** - 22,5x22,5  
Cementina A

55

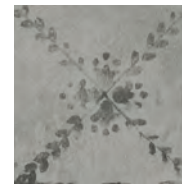
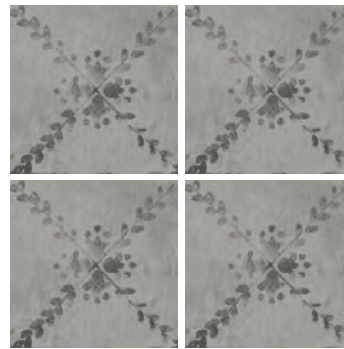

**180824** - 22,5x22,5  
Cementina B

55



**180834** - 22,5x22,5  
Cementina C

55

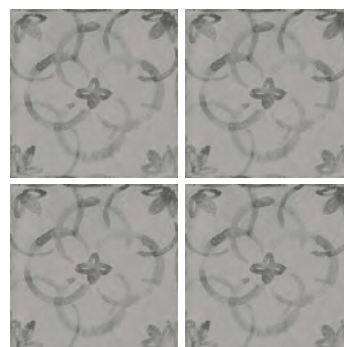

**180844** - 22,5x22,5  
Cementina D

55

**PAVÉ 3.0**



# Pavé 3.0

GRES PORCELLANATO . PORCELAIN STONEWARE . GRÈS CÉRAME . FEINSTEINZEUG

22,5x45 | 22,5x22,5  
9"x 18" | 9"x 9"

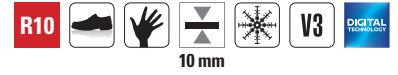

## TAUPE

indoor



180672 - 22,5x45

50



180682 - 22,5x22,5

50



180712 - 22,5x22,5 Cementina Blend (16 Pz)

55



180722 - 22,5x22,5  
Cementina A

55

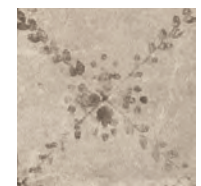
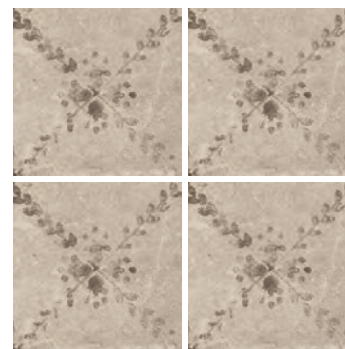

180822 - 22,5x22,5  
Cementina B

55



180832 - 22,5x22,5  
Cementina C

55

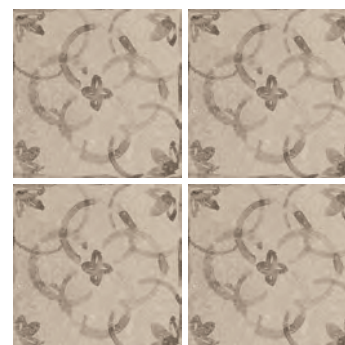

180842 - 22,5x22,5  
Cementina D

55





**COTTO**

*indoor*

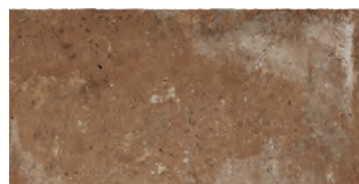

**180673** - 22,5x45

50

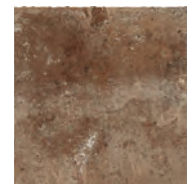

**180683** - 22,5x22,5

50



**180713** - 22,5x22,5 Cementina Blend (16 Pz)

55



**180723** - 22,5x22,5  
Cementina A

55

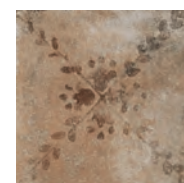
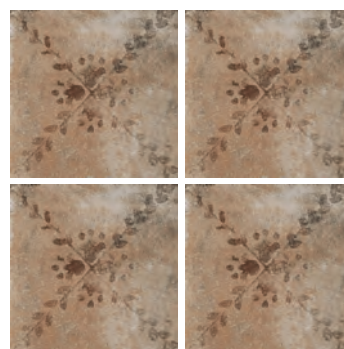

**180823** - 22,5x22,5  
Cementina B

55

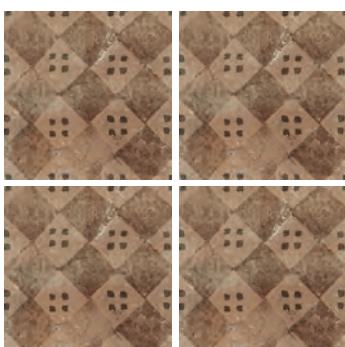

**180833** - 22,5x22,5  
Cementina C

55

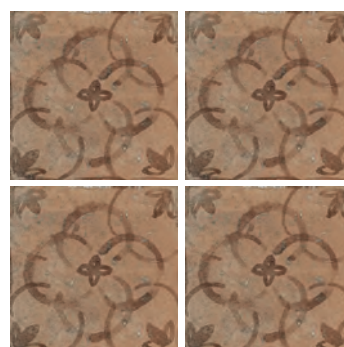

**180843** - 22,5x22,5  
Cementina D

55

**PAVÉ 3.0**



# Pavé 3.0

GRES PORCELLANATO . PORCELAIN STONEWARE . GRÈS CÉRAME . FEINSTEINZEUG

22,5x45 | 22,5x22,5  
9" x 18" | 9" x 9"

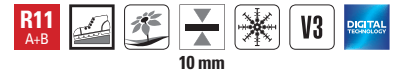

## GRIGIO

outdoor



180731 - 22,5x45

50



180741 - 22,5x22,5

50

## TAUPE



180732 - 22,5x45

50



180742 - 22,5x22,5

50

## COTTO



180733 - 22,5x45

50



180743 - 22,5x22,5

50

## ANTRACITE



180734 - 22,5x45

50



180744 - 22,5x22,5

50

### PEZZI SPECIALI

Special pieces . Pièces spéciales . Formteile



Battiscopa  15  
7x45

180851 - Grigio  
180852 - Taupe  
180853 - Cotto  
180854 - Antracite



Elemento a L  54  
15x30

180861 - Grigio  
180862 - Taupe  
180863 - Cotto  
180864 - Antracite

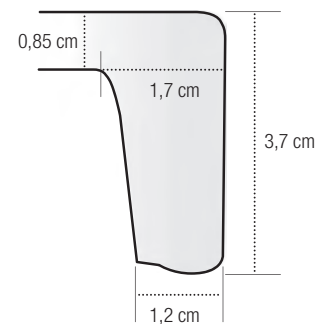





Cotto 22,5x22,5 - Cotto 22,5x45

Le misure in pollici sono indicative.  
Le misure in cm sono da considerarsi nominali e sono le uniche da usare come riferimento.

Please note:  
The sizes in inches are indicative.  
The sizes in cm are real and to be used as reference.



## DESTINAZIONI D'USO CONSIGLIATE

Examples of applications suggested . Domaines d'utilisation conseillés . Empfohlene Anwendungsbereiche.

Ville, Appartamenti,  
Negozi, Uffici, Ristoranti,  
Bar, Alberghi,  
Centri commerciali, Musei,  
Edifici per frequentazione  
pubblica collettiva.

Villas, Apartments,  
Shops, Offices, Restaurants,  
Bars, Hotels, Shopping  
centers, Museums,  
Buildings used by the public.

Villas, Appartements,  
Magasins, Bureaux,  
Restaurants, Cafés, Hôtels,  
Centres commerciaux,  
Musées, Bâtiments destinés  
au public.

Häuser, Wohnungen,  
Geschäfte, Büros, Restaurants,  
Cafés, Hotels,  
Einkaufszentren, Museen,  
Öffentliche Gebäude.

### INTERNI

Soggiorno, Cucina, Bagno,  
Sale da pranzo, Corridoi,  
Camere da letto,  
Sala ricevimento,  
Sale convegno.

### INDOOR

Living Rooms, Kitchens,  
Bathrooms, Dining rooms,  
Corridors, Bedrooms,  
Reception rooms,  
Conference rooms.

### INTÉRIEURS

Salles de séjour, Cuisines,  
Salles de bains, Salles à  
manger, Couloirs, Chambres à  
coucher, Salles de réception,  
Salles des congrès.

### INNENBEREICHE

Wohnzimmer, Küche,  
Badezimmer, Esszimmer,  
Korridore, Schlafzimmer,  
Empfangsräume,  
Tagungssäle.

### ESTERNI R11 A+B

Passaggi pubblici  
in sicurezza.  
Terrazze, Balconi, Verande,  
Porticati, Passaggi pubblici in  
sicurezza.

### OUTDOOR R11 A+B

Safe road crossings.  
Terraces, Balconies,  
Verandas, Porches,  
Safe road crossings.

### EXTÉRIEURS R11 A+B

Des passages publics  
sécurisés.  
Terrasses, Balcons, Vérandas,  
Porches, Des passages  
publics sécurisés.

### AUSSENBEREICHE R11 A+B







Oeffentliche wege mit  
gepruefter rutschhemmung.  
Terrassen, Balkons,  
Veranden, Laubgänge,  
Öffentliche Schutzwege.

## IMBALLI

Weights and pack . Poids et emballages . Gewicht und Verpackung





### FORMATI

Sizes . Formats . Formate

	Pz x 	m <sup>2</sup> x 	kg x 	 x 	m <sup>2</sup> x 	kg x 
22,5x45,0	12	1,215	26,400	39	47,385	1030
22,5x22,5	24	1,215	26,400	39	47,385	1030
22,5x22,5 Decoro	24	1,215	26,400	26	31,590	686
7x45 Battiscopa	12	0,378	11,170	65	24,570	726
15x30 Elemento a L	8	0,360	9,074	52	18,720	472

## CARATTERISTICHE TECNICHE DI SUPERFICIE

Technical surface properties . Caractéristiques techniques des surfaces . Technische Eigenschaften der Oberfläche

	 <b>Resistenza alle macchie (Pulibilità).</b> Resistance to staining. Résistance aux produits tachants. Beständigkeit gegen fleckenbildner <b>ISO 10545/14</b>	 <b>Resistenza agli acidi e alle basi.</b> Resistance to acids and bases. Résistance aux acides et aux bases. Beständigkeit gegen Säuren und Laugen. <b>ISO 10545/13</b>	 <b>Scivolosità.</b> Slipperiness. Glissance. Rutschhemmungen eigenschaften. <b>B.C.R.A.</b>	 <b>Scivolosità.</b> Slipperiness. Glissance. Rutschhemmungen eigenschaften. <b>DIN 51130 DIN 51097</b>	 <b>Scivolosità.</b> Slipperiness. Glissance. Rutschhemmungen eigenschaften. <b>DCOF Ansi A 137.1.2012</b>	
			Cuoio asciutto	Gomma bagnata	R	ABC
22,5x22,5 - 22,5x45	5	G.A.	-	-	R 11 A+B	-
22,5x22,5 - 22,5x45	5	G.A.	-	-	R 10	-



**PAVÉ 3.0 è un prodotto realizzato con la tecnologia digitale di Sichenia.**

*Sichenia Digital Technology* è un avanzato procedimento di produzione che consente un incredibile realismo nella realizzazione di superfici in gres porcellanato; prova ne sono l'elevato numero di variazioni grafiche ottenibili e la sorprendente precisione nella riproduzione dei minimi particolari della materia naturale.

Sichenia sceglie ancora una volta l'avanguardia della tecnologia disponibile per conferire il massimo grado di ricercatezza al design ed alle prestazioni della proprie collezioni.

**PAVÉ 3.0 is a product manufactured using Sichenia's digital technology.**

*Sichenia Digital Technology* is an advanced manufacturing process that enables incredible realism in the production of porcelain stoneware tiles; proof of this lies in the large number of graphic variations obtainable and the astonishing fidelity with which the smallest detail of the natural material is reproduced.

Sichenia has once again the chosen cutting-edge technology available to lend its collection the utmost sophistication in design and performance.

**PAVÉ 3.0 est un produit réalisé suivant la technologie numérique de Sichenia.**

*Sichenia Digital Technology* est un processus avancé qui permet un réalisme incroyable en réalisant des surfaces en grès cérame ; le grand nombre de variations graphiques réalisables et la précision surprenante au niveau de la reproduction des moindres détails de la matière naturelle en sont la preuve.

Sichenia choisit une fois de plus l'avant-garde de la technologie disponible pour empreindre le design et les performances de ses collections du plus haut degré de raffinement.

**PAVÉ 3.0 ist ein mit der Sichenia-Digitaltechnologie geschaffenes Produkt.**

Die *Sichenia Digital Technology* ist ein fortschrittliches Produktionsverfahren, das eine hervorragende Wirklichkeitstreue bei der Herstellung von Oberflächen aus Feinsteinzeug ermöglicht. Beweis dafür sind die hohe Zahl von erzielbaren graphischen Varianten sowie die überragende Genauigkeit bei der Nachbildung der kleinsten Details des Materials aus der Natur.

Sichenia entscheidet sich erneut für die fortschrittliche, verfügbare Technologie, um dem Design und den Leistungen ihrer Kollektionen eine besondere Auserlesenheit zu verleihen.



La riproduzione, la pubblicazione, e la distribuzione, totale o parziale, di tutto il materiale originale contenuto in questo documento sono espressamente vietate in assenza di autorizzazione da parte di Sichenia.

Sichenia si riserva di modificare i prodotti senza preavviso, declinando ogni responsabilità relativa a danni diretti o indiretti derivanti da tali modifiche.

I colori e le caratteristiche estetiche dei materiali illustrati nel presente catalogo sono da ritenersi puramente indicativi.

Per le informazioni e i dati relativi ai codici, imballaggi e pesi occorre sempre consultare l'ultimo listino aggiornato e in vigore.

The reproduction, publication, and distribution, total or partial, of all the original material contained herein is expressly prohibited without the prior consent of Sichenia.

Sichenia reserves the right to make changes to the products without notice, and shall not be liable for any direct or indirect damages arising from any changes.

The colours and the aesthetic characteristics of the products shown in this catalogue are purely illustrative.

For information and data concerning codes, packaging and weight always refer to the last updated price list in force.

La reproduction, la publication et la distribution, totales ou partielles, de tout le matériel original contenu dans ce document sont expressément interdites sans l'autorisation de Sichenia.

Sichenia se réserve la faculté de modifier les produits sans préavis, en déclinant toute responsabilité relative à des dommages directs ou indirects dérivant d'éventuelles modifications.

Les couleurs et les caractéristiques esthétiques du matériel illustré dans ce catalogue sont fournis à titre purement indicatif.

Pour les informations et les données relatives aux codes, aux emballages et aux poids, il est toujours nécessaire de consulter le dernier tarif mis à jour et en vigueur.

Die vollständige oder auszugsweise Vervielfältigung, Veröffentlichung und Verbreitung des gesamten, in diesem Dokument enthaltenen Originalmaterials, ist ohne Genehmigung der Firma Sichenia ausdrücklich untersagt.

Sichenia behält sich das Recht vor, die Produkte ohne vorherige Ankündigung zu ändern und haftet nicht für direkte oder indirekte, durch eventuelle Änderungen verursachte Schäden.

Die Farben und ästhetischen Merkmale des im vorliegenden Katalogs abgebildeten Materials sind rein zur Information und nicht bindend.

Für Informationen zu den Daten der Artikelnummer, Verpackungen und Gewichten siehe immer die neuste, jeweils gültige Preisliste.



*"Sichenia" è un brand italiano che produce pavimenti e rivestimenti in ceramica pensati per l'architettura contemporanea. Una gamma di prodotti di grande pregio estetico e resistenza, ottenuti con materie prime di alta qualità modellate dall'estro progettuale italiano.*

*"Sichenia" is an Italian brand that manufactures ceramic wall and floor coverings designed for contemporary architecture. It offers a range of products with high aesthetic quality and resistance, obtained with high quality raw materials shaped with Italian design flair.*



**Sichenia è da sempre concretamente impegnata nella tutela dell'ambiente.**

*Utilizza processi produttivi e tecnologie all'avanguardia che riducono notevolmente l'impatto ambientale delle attività in ogni fase esecutiva, dalla progettazione all'imballaggio finale del prodotto.*

**Sichenia has always been actively involved in safeguarding the environment.**

*It adopts avant-garde production processes and technologies that significantly reduce the environmental impact of each execution phase, from design to the final packaging of the product.*

# Pavé 3.0



Sichenia Gruppo Ceramiche S.p.A.

Via Toscana, 12 - 41049 Sassuolo (Modena, Italy)

Tel. +39 0536.81.84.11 - Fax Italia +39 0536.81.01.05 / export +39 0536.80.08.15

[info@sichenia.it](mailto:info@sichenia.it) - [www.sichenia.it](http://www.sichenia.it)